

03251544

ermaf //

→ www.docuthek.com

Operating instructions Heater GP 70 ACU

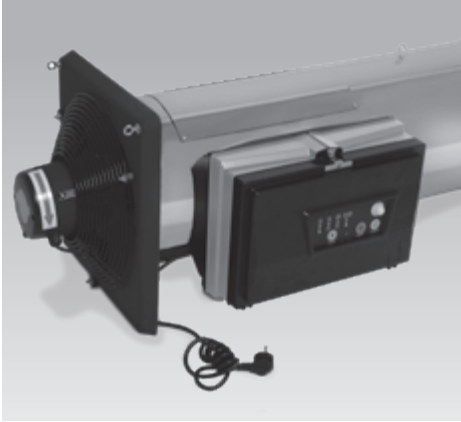

Contents

Heater GP 70 ACU	1
Contents	1
Safety	1
Checking the usage	2
Installation	2
Tightness test	3
Wiring	3
Connection diagram	4
Burner Chip Card (BCC)	6
Setting the switch-on delay	6
Commissioning	6
ACU control panel	7
Switching on	7
Switching off	7
Setting mode	8
Adjusting the heater	8
Cleaning	10
Assistance in the event of malfunction ...	12
Maintenance	18
Checking the safety functions and burner operation	20
Accessories	20
Spare parts	22
Technical data	23
Declaration of conformity	23
Logistics	23
Goods return form	24
Contact	24

Safety

Please read and keep in a safe place



Please read through these instructions carefully before installing or operating. Following the installation, pass the instructions on to the operator. This unit must be installed and commissioned in accordance with the regulations and standards in force. These instructions can also be found at www.docuthek.com.

Explanation of symbols

1, 2, 3... = Action
 > = Instruction

Liability

We will not be held liable for damage resulting from non-observance of the instructions and non-compliant use.

Safety instructions

Information that is relevant for safety is indicated in the instructions as follows:

DANGER

Indicates potentially fatal situations.

WARNING

Indicates possible danger to life and limb.

CAUTION

Indicates possible material damage.

All interventions may only be carried out by qualified gas technicians. Electrical interventions may only be carried out by qualified electricians.

Persons under the age of 18 as well as persons with reduced physical, sensory or mental capabilities or lack of experience and knowledge are not allowed to use, clean or service this device. Staying near the device or its use is prohibited, even if said persons are supervised or have been instructed on the safe use of the devices and are aware of the resulting dangers.

Conversion, spare parts

All technical changes are prohibited. Only use OEM spare parts.

Checking the usage

GP 70

Heater with direct, open combustion for animal sheds and horticultural greenhouses. Depending on the type and setting, the heater can be operated with natural gas or LPG (propane/butane).

This function is only guaranteed when used within the specified limits – see page 23 (Technical data). Any other use is considered as non-compliant.

Type code

Code	Description
GP	Heater
70	Capacity 70 kW, jet length 50 m

Part designations

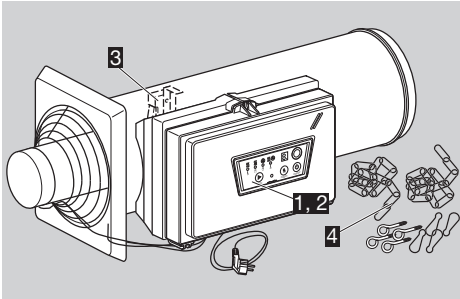

- 1** Burner control unit ACU
- 2** Gas combination control CG
- 3** Vane
- 4** Assembly accessories

Type label

Air circulation, electrical connection rating, voltage, rated heat input, gas type, category, supply pressure, burner pressure, enclosure: see type label.



- Before installation, check whether the device is suitable for the regional gas type and the specified limits, see type code and page 23 (Technical data).

Installation

⚠ DANGER

Danger of death! Gases are generated during the storage of slurry which remain partly dissolved in the liquid. If the slurry is strongly agitated during mixing and purging, poisonous, explosive gases such as hydrogen sulphide and methane are released. If an ignition source is present, the released gas can explode.

To avoid damage during operation, please observe the following:

- Switch off the heater before mixing and purging the slurry.
- Close the slide valves when storing slurry outside.
- The fan for the air supply must not be part of a closed pipe system.
- The space to be heated must be adequately ventilated.

For mechanical extraction equipment: at least 10 m³/h of air per installed capacity.

In the case of natural ventilation, the structure must have two apertures with a free opening area of 60 x B in cm². "B" is the installed capacity in kW. Replacement of the full air volume per hour is thus ensured.

- In the case of natural ventilation, the maximum allowable total capacity of the heater is 1 kW per 20 m³ of volume.
- Respect the safety distance of the heater to inflammable materials, see "Installation position".
- Consult your fire insurance provider and/or local fire protection engineer to assess the foreseeable, general risk of fire.
- For cleaning, care and maintenance, note the applicable national regulations and directives.
- No condensation permitted. Comply with ambient temperature, see page 23 (Technical data).

Installation position

- ▷ To ensure that the vane functions faultlessly, install the unit in the horizontal position.
- ▷ Note the safety distance to walls and inflammable materials.

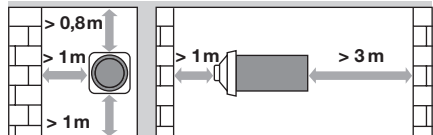

- ▷ Ensure sufficient free space around the device. There must be no obstructions in front of the inlet and outlet side of the heater.
- ▷ To avoid overheating, do not cover the electric motor.

Connecting the gas supply

- ▷ If the heater is suspended on chains, use an approved flexible gas hose.
- 1** Disconnect the system from the electrical power supply.
- 2** Shut off the gas supply.
- 3** Remove the sealing plug at the inlet tube of the gas combination control CG.

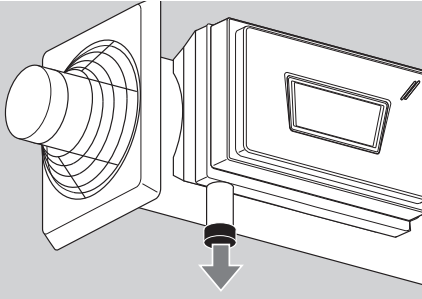

- 4** Connect the gas pipe with threaded connection (R 3/4" external thread) or gas hose, see page 20 (Accessories), to the inlet tube of the gas combination control.
- ▷ Use approved sealing material only.
 - ▷ Note the maximum inlet pressure, see page 23 (Technical data).

Tightness test

- 1** Disconnect the system from the electrical power supply. The mains plug may only be pulled out once the device has been switched off.
- ▷ The valves are closed when de-energized.
- 2** Open the cover of the ACU.

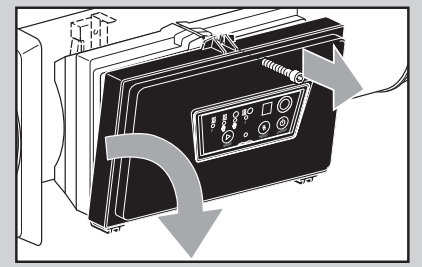

- ▷ To do so, turn the cross-head screw anti-clockwise several turns so that it can be lifted.
- 3** Open the test point for p_u on the CG.
- 4** Connect a pressure gauge to test point p_u .

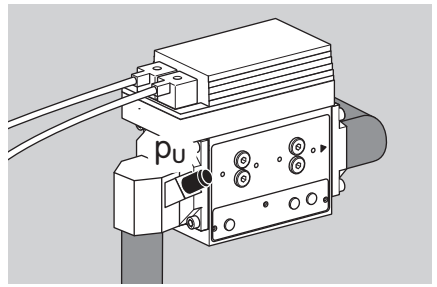

- 5** Switch on the power supply.
- 6** Release the gas supply.
- ▷ Inlet pressure $p_{u \text{ max.}} = 70 \text{ mbar}$.
- 7** Shut off the gas supply.
- 8** Check the gas pressure on the pressure gauge.
- ▷ The pressure must not drop.

Wiring

! CAUTION

Danger of electric shocks!

- Before working on possible live components, ensure the unit is disconnected from the power supply.
- 1** Disconnect the system from the electrical power supply. The mains plug may only be pulled out once the device has been switched off.
 - 2** Shut off the gas supply.
 - 3** Open the housing cover of the ACU.
 - ▷ To do so, turn the cross-head screw anti-clockwise several turns so that it can be lifted.
 - 4** Open the cover of the burner control unit.

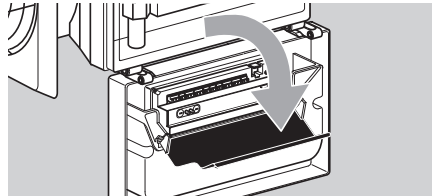

Connection diagram

- ▷ The burner control unit is fitted with coded connectors to prevent them being mixed up.

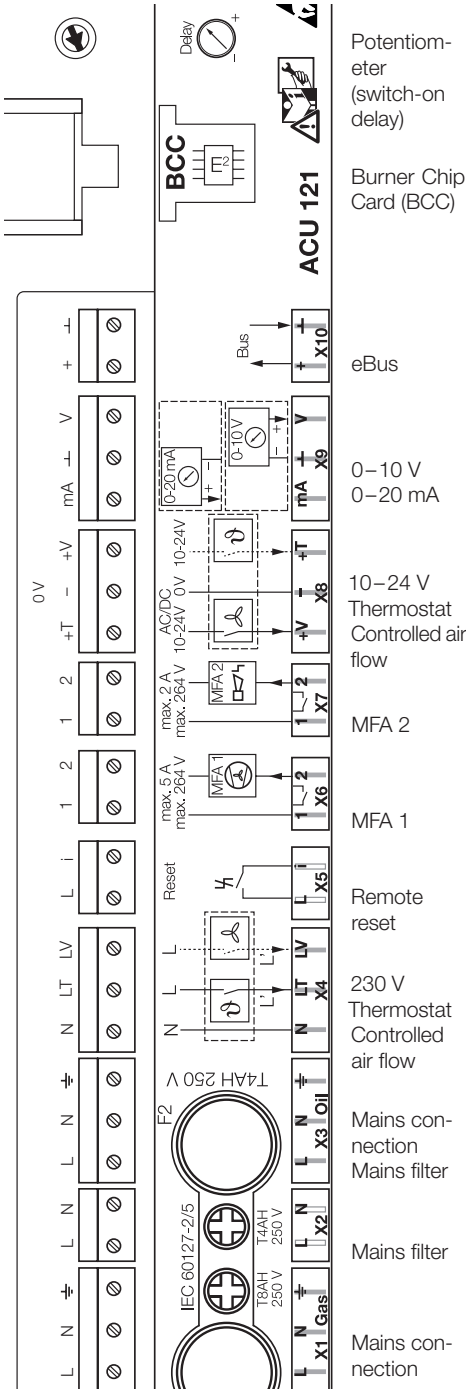

Connecting the room thermostat

! CAUTION

To avoid damage to the heater, please observe the following:

- Provide post-cooling for the heater. The heater requires a continuous supply of 230 V AC, 50 Hz.
 - In case of a power failure, an emergency power supply unit should automatically take over the power supply. Emergency power supply units with a cardan shaft drive for tractor attachment are also suitable.
- ▷ Use a room thermostat with a hysteresis of $\pm 1^\circ\text{C}$. It switches on if the room temperature is 1°C less than the set temperature and switches off again once the room temperature is 1°C more than the set temperature.
 - ▷ The floating connectors X4 (230 V) or X8 (24 V) are used to connect the room thermostat.
 - ▷ If the room thermostat is connected to the mains supply of other connectors (connector X1 or X3), the heater will be damaged.

Connecting a single heater to a room thermostat

5 Connect a room thermostat for 230 V AC.

- ▷ 1. Power supply via the heater.

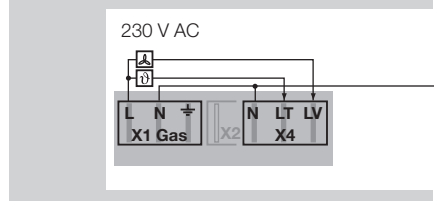

- ▷ 2. Power supply via the environmental control computer.

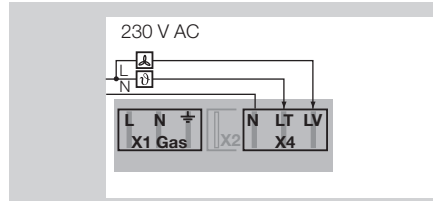

5 Connect a room thermostat for 24 V DC/AC to connector X8.

- ▷ The 24 V power supply must always be from an external source.

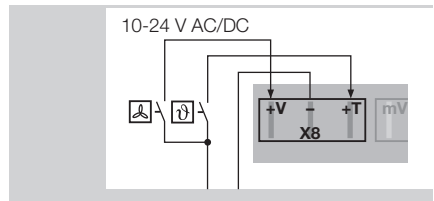

Connecting multiple heaters to a room thermostat or an environmental control computer

5 Connect a room thermostat for 230 V AC.

- ▷ 1. Power supply via the heater.

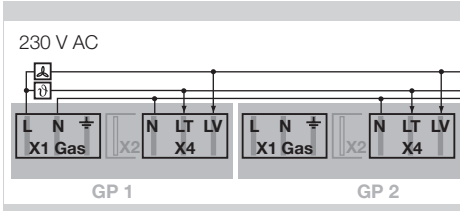

- ▷ Only one bridge may be connected in a single heater between connectors X1 and X4. "N" may be connected to all successive heaters between connectors X4 only.

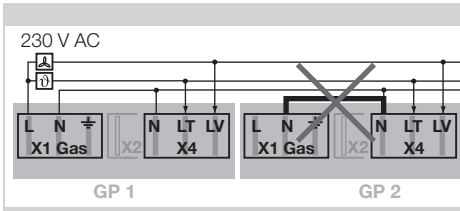

- ▷ 2. Power supply via the environmental control computer.

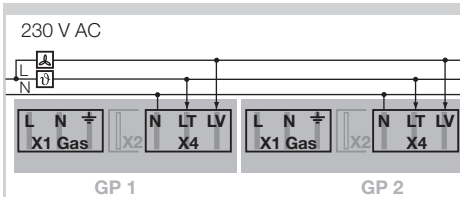

5 Connect a room thermostat for 24 V DC/AC to connector X8.

- ▷ The 24 V power supply must be from an external source.

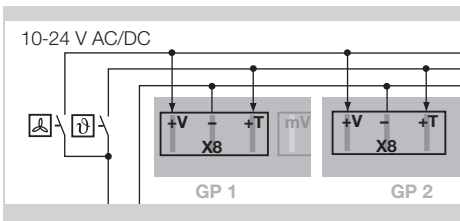

Remote reset

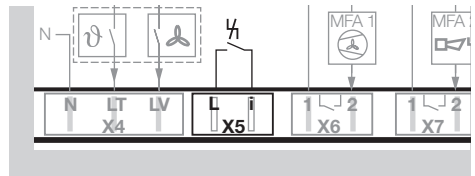

- ▷ An external remote reset may be connected to connector X5.

Multi-functional outputs (MFA)

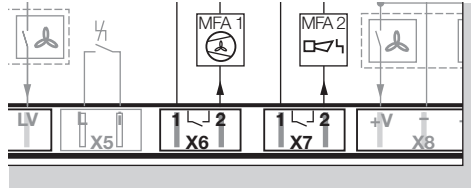

- ▷ Floating multi-functional outputs can be parameterized using connectors X6 and X7. There are two methods of completing this parameterization:

The PC software for burner control units BCSofT can be used via the optical interface on the burner control unit, see page 20 (Accessories).

The "Setting mode" menu can be opened using the MODE selection button (heater OFF) and used for parameterizing the outputs, see page 8 (Setting mode).

- ▷ **MFA 1, external fan** (max. 5 A)

For improved air circulation in the room, an additional fan can be connected. The external fan can be actuated with an adjustable delay (BCSofT) for switching it on and off. The exact time relates to the operation of the integrated fan.

- ▷ Possible parameterization options:
 - Inactive: the external fan is not actuated.
 - Integrated fan active: the external fan is actuated at the same time as the integrated fan.
 - Integrated fan inactive: the external fan is actuated when the integrated fan of the heater switches off.
 - Modulation enable: the external fan is not actuated until the heater starts modulating operation.

- ▷ **MFA 2, status signal** (max. 2 A)
Possible parameterization options:
 - Fault NO (default setting):
For example, the input for a horn can be set to NO.
 - Fault NC:
The input on an environmental control computer can be set to NC (e.g. to indicate a cable discontinuity).
 - Operation
 - Standby

Burner Chip Card (BCC)

- ▷ All the data relevant to the device are saved on the BCC and the internal device memory (EEProm). In addition, the parameters are saved on the BCC.

WARNING

Danger of electric shocks!

- Before working on possible live components, ensure the unit is disconnected from the power supply.
- If the BCC is removed from the burner control unit, the heater will be non-functional.
- ▷ In the event of faults which cannot be rectified by authorized trained personnel, contact the supplier.
- ▷ The BCC can be removed from the burner control unit and submitted for diagnostic purposes by agreement with the supplier.

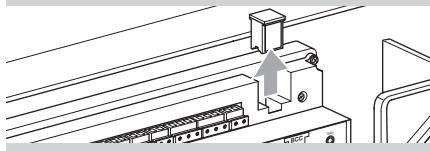

- ▷ If no other fault is active, the heater can be readied for use again by inserting a new BCC. The BCC must be compatible with the heater, the version and the gas type used.

Setting the switch-on delay

- ▷ If multiple heaters switch on at the same time, there can be a gas and/or power shortage on individual devices. To avoid this happening, adjust the switch-on delay using the potentiometer on the burner control unit.
- ▷ The potentiometer is set to 0 s at the factory.

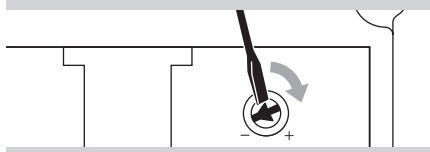

- ▷ If necessary, a switch-on delay of 5 to 10 s can be set between the devices.

- 6 After completing the wiring, close the cover and the housing cover on the burner control unit again.
- 7 Switch on the power supply.
 - ▷ If a switch-on delay has been programmed, a circulating dash will be displayed when the voltage supply is switched on to indicate that the switch-on delay is running.



- 8 Release the gas supply.
- 9 Commission the heater.

Commissioning

WARNING

To avoid damage to the heater, please observe the following:

- Ensure that the heater, gas pipes, mains voltage supply and room thermostat have been installed by authorized trained personnel according to the regulations.
- The Burner Chip Card (BCC) must be compatible with the heater, the version, the gas type used and the factory default parameters.
- The heater may only be operated with the gas type specified on the type label.
- If the device needs to be converted to be operated with a different gas type:
 1. Use the correct nozzle, see page 22 (Spare parts).
 2. Set the appropriate pressure on the burner, see table on page 8 (Adjusting the heater), and then seal the gas pressure setting.

ACU control panel

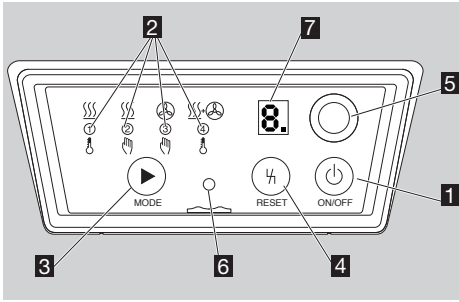

- 1** ON/OFF
- 2** LEDs
- 3** MODE selection button
- 4** RESET button
- 5** Status indicator light
- 6** Optical interface
- 7** 7-segment display

Description of function

- 1** ON/OFF :
To switch the heater on and off
- 2** LEDs:
To indicate the chosen operating mode

Operating mode	Explanation
	The burner control unit waits for the signals for controlled air flow or heating (automatic)
	Continuous heating (manual)
	Controlled air flow in continuous operation (manual)
	Controlled air flow in continuous operation and heating when a thermostat signal is applied (automatic)

- 3** MODE selection button:
Setting mode can be accessed by pressing and holding the MODE selection button when the heater is switched off, see page 8 (Setting mode). The multi-functional outputs can be assigned and the eBus address specified in this mode.
- 4** RESET button:
To reset the device after the occurrence of a fault
- 5** Status indicator light:
red: fault
yellow: standby/ready for operation
green: in operation
- 6** Optical interface:
The PC software BCSof can be used with the PC opto-adaptor via this interface, see page 20 (Accessories).

- 7** 7-segment display:

To display error codes, the flame signal or the number of operating cycles. The decimal point indicates that another figure follows.

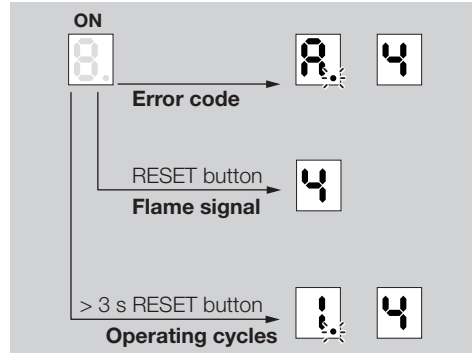

Error code: an error is displayed immediately in the form of an alternating letter and number indicating a warning or fault, see page 12 (Assistance in the event of malfunction).

Flame signal: pressing the RESET button displays the flame signal, see page 9 (Flame signal).

Operating cycles: press and hold the RESET button for more than 3 s to show the number of operating cycles in changing displays, see page 18 (Maintenance).

- Press the RESET button to exit the display of the flame signal or operating cycles.

Switching on

- Press ON/OFF .
- The LED for the last selected operating mode will flash. A different operating mode can be selected within 2 s. If you retain the selection, the flashing light will change to permanently lit after 2 s.
- The heater will start once the thermostat signal has been applied and the set switch-on delay elapsed, see page 6 (Setting the switch-on delay).
- The burner starts up and operates in the last selected operating mode.

Switching off

- Press ON/OFF .
- The burner control unit display and the burner will switch off immediately. Mains voltage is still supplied however. The display indicates “-”.
- The main fan cools the heater down until it reaches switch-off temperature.

! CAUTION

- Do not disconnect the heater from the electrical power supply until the post-cooling process has been completed.
- The display “-” will go out.

Setting mode

- ▷ Press and hold the MODE selection button when the heater is switched off to go to Setting mode.
- Switch off the heater .
- ▷ Mode E: eBus addresses can be saved.
- Mode A/F: multi-functional outputs can be parameterized.

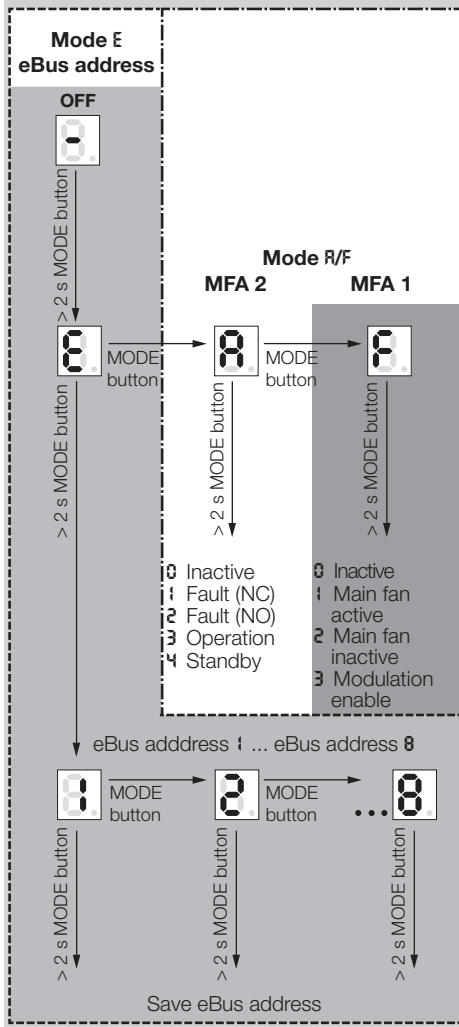

- ▷ Press the RESET button to return to the previous menu.
- ▷ After a timeout of 20 s, the display will automatically return to the initial mode. The display indicates “-”.

Adjusting the heater

Burner gas pressure p_G

p_U = Inlet pressure

p_G = Gas pressure on the burner

- ▷ The gas pressure on the burner is adjusted using p_G on the combination control.

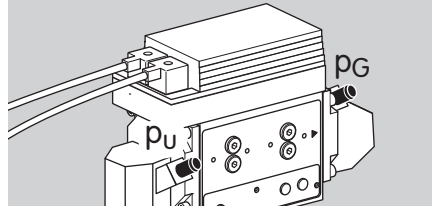

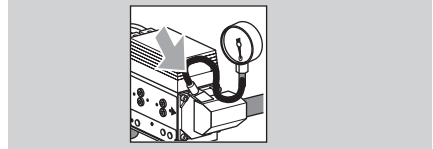
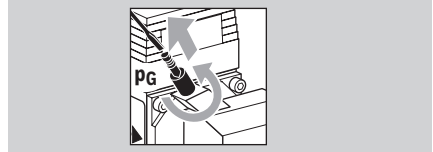

- ▷ For this, the outlet pressure p_G must be measured on the combination control.

- 1 Disconnect the system from the electrical power supply. The mains plug may only be pulled out once the device has been switched off and post-cooling is complete.
- 2 Shut off the gas supply.
- 3 Open the pressure test point.



- 4 Switch on the power supply.
- 5 Release the gas supply.

- ▷ The inlet pressure p_U must comply with the technical data, see page 23 (Technical data).

- 6 Switch on the burner control unit. Press the ON/OFF button  until an LED lights up.
- 7 Select the Heating  operating mode.
- 8 Let all heaters burn for at least 20 s.

- ▷ The required gas pressure on the burner depends on the heating value/Wobbe index.

- 9 Select the required gas pressure on the burner from the tables:

Natural gas, LPG			
Gas type	Heating value	Wobbe index	[mbar]
	[MJ/m ³]		
Natural gas L G 25	32.49	41.53	12.5
Natural gas H G 20	37.78	50.71	9.0
LPG G 30	125.81	87.34	22.0

Gas type	G+ K gas*		[mbar]
	Wobbe index [MJ/m ³]		
	min.	max.	
G+ K gas	43.46	45.3	12.5

* see page 23 (The Netherlands)

- ▷ Converting the heating value/Wobbe index to kWh/m³:

$$\text{kWh/m}^3 = \frac{\text{Heating value/Wobbe index [MJ/m}^3\text{]}}{3.6}$$

- ▷ Always use a pressure gauge to adjust the burner gas pressure. The white scale on the adjusting screw may differ.
- 10** If all heaters are heating at the same time, compare the required gas pressure on the burner with the gas pressure p_G read off the pressure gauge, adjust it and monitor the pressure gauge.

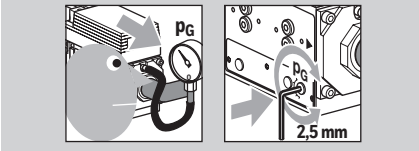

- ▷ The flame must be blue and must remain inside the device.
- ▷ Check and adjust the burner pressure p_G and flame signal on all devices so that the system operates correctly.

- 11** Remove the pressure gauge from the test point.

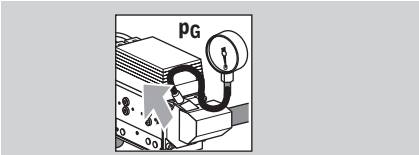

- 12** Close the pressure test point.

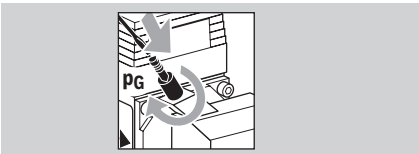

Flame signal

- ▷ The flame signal can be displayed while the burner is operating.

- 1** Press the RESET button to display the flame signal.

- ▷ The flame signal is shown in coded form as a number from 0 to 9. This number must be multiplied by a factor of 2. The result of this multiplication is the level of the flame signal in μA . Example: the number 3 corresponds to a flame signal of 6 – 8 μA .

Display	Flame current [μA]	Display	Flame current [μA]
0	0–2	5	10–12
1	2–4	6	12–14
2	4–6	7	14–16
3	6–8	8	16–18
4	8–10	9	18...

- 2** Check the flame signal.
- ▷ The flame signal is displayed for 20 s.
- 3** Press the RESET button to exit the flame signal display.

Cleaning

! CAUTION

To ensure that no damage occurs during operation and cleaning, please observe the following instructions. Otherwise, injuries or damage to the device may occur and/or the function of the device may be impaired, and the manufacturer's warranty will be cancelled.

- Sharp-edged metal sheets. Always wear protective gloves.
- After cleaning, check that the components on and in the heater are in good condition. The device may only be restarted if all safety devices have been installed and the safety functions have been checked.
- Clean the heater once a year when used in horticulture and at regular intervals as well as after each fattening period when used in agriculture, as described below. Inadequate or irregular cleaning can cause damage to the device or lead to fire damage. For example, dirt particles can catch fire and can be blown out of the heater.

- 1 Switch off the burner control unit ACU.
 - 2 Disconnect the system from the electrical power supply.
- ▷ The mains plug may only be pulled out once the device has been switched off and post-cooling is complete.
- 3 Shut off the gas supply.
 - 4 Check the cover on the burner control unit and the housing cover to ensure they are both tightly closed.

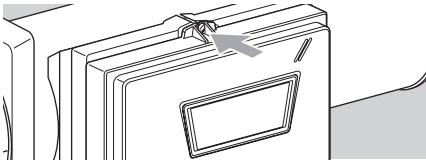

- ▷ The GP is made of high-quality stainless steel and is resistant to external influences such as dirt and moisture.
- ▷ The GP can be cleaned carefully both inside and outside with a high-pressure cleaner.
- ▷ The water jet from the high-pressure cleaner can cause serious damage to the heater components. For example, the blade can be bent or other parts such as the spark plug or rubber seals can be displaced. Avoid direct contact.
- ▷ Do not direct the water jet straight at electrical components such as the vane.

- ▷ Do not spray water or chemical cleaning agents directly into the space between the fan shaft/impeller wheel and motor. Do not clean the fan shaft/impeller wheel with a high-pressure cleaner.

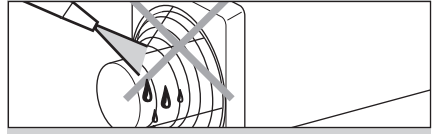

- ▷ The housing cover and cable glands on the ACU must be closed during the cleaning process.
- ▷ The electrical components are protected from moisture by additional water drip edges on the housing cover. Direct water influence on the edges of the housing cover should be avoided.
- ▷ A downward slope inside the device ensures that dirty water drains out.
- ▷ Never direct the nozzle of the high-pressure cleaner at the heater when the cleaner is set to "water jet". Always use the spray setting.
- ▷ The distance between the nozzle and the surface to be cleaned must be at least 50 cm. Placing the high-pressure cleaner at too short a distance can cause serious damage to the device.

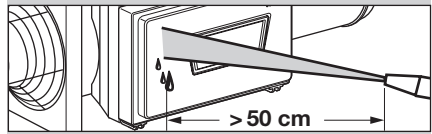

- ▷ To facilitate cleaning of the components inside the housing, the maintenance cover on the casing can be opened.

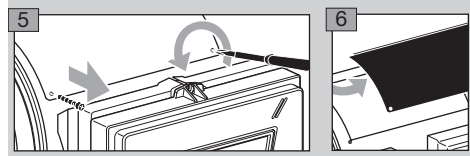

- 7 Clean the grille from the outside using a cloth.
- ▷ Clean the fan, vane and plates for the air intake using a cloth only.

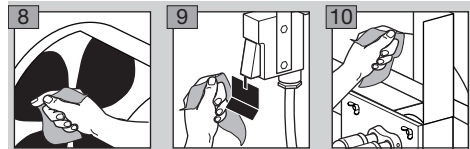

- 11 Clean the interior of the device carefully using air.
- ▷ The vane must not be bent.
- 12 Check that the vane switch is functional.

- ▷ If the vane is moved a little in the direction of the arrow, a quiet click can be heard. This means that the switching path is correct.

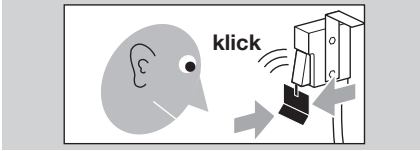

Assembly

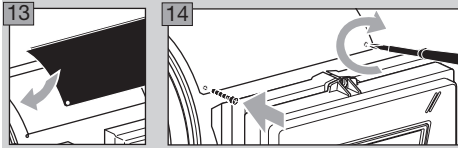

- ▷ Check the burner is functioning faultlessly in normal operation, see page 20 (Checking the safety functions and burner operation).

- 15** When operating with propane, check that the breather orifice of the pressure reducer on the connection kit is clean.

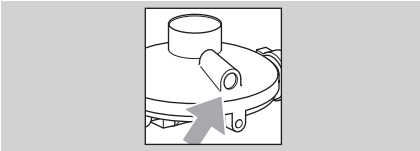

- 16** After cleaning, check that all the parts on and in the heater are in the correct positions, for example whether the rubber seals between the electrodes and terminal boots are fitted correctly.
- 17** Chemical cleaning agents, disinfectants and/or pesticides contain corrosive substances which can even corrode stainless steel. Always rinse the devices with water after cleaning using such agents to remove any residue of these agents from the surface.
- 18** After cleaning, select operating mode ③ (Controlled air flow) so that the interior of the device can dry properly.
- 19** After cleaning the heater, check it is functioning faultlessly in normal operation, see page 20 (Checking the safety functions and burner operation).

Assistance in the event of malfunction

⚠ WARNING

To avoid harm to persons and animals or damage to the heater, please observe the following:

- Electric shocks can be fatal! Before working on possible live components, ensure the unit is disconnected from the power supply.
- Fault-clearance must only be undertaken by authorized trained personnel!
- Repairs to components, e.g. the burner control unit ACU or the combination control CG, may only be carried out by the manufacturer. Otherwise, the guarantee will be cancelled. Unauthorized repairs or incorrect electrical connections, e.g. the connection of power to outputs, can cause gas valves to open and the burner control unit to become defective. In this case, fail-safe operation can no longer be guaranteed.
- (Remote) resets may only be conducted by authorized trained personnel with continuous monitoring of the devices concerned.

- ▷ In the event of an installation fault, the burner control unit closes the gas valves and the status indicator light will be red at the latest after a restart has been unsuccessful.
- ▷ The 7-segment display will show an error code in the form of a letter with a decimal point and a number alternately indicating a warning. Together with the red status indicator light, this then constitutes a fault.
- ▷ Warnings and faults may be cleared only using the remedies described below.

Internal wiring

- ▷ To rectify a fault, it is sometimes necessary to check the internal wiring.

- 1** Open the housing cover of the burner control unit.
- 2** Undo the two screws (M3) using a Phillips screwdriver and remove the complete plastic cover from the burner control unit.

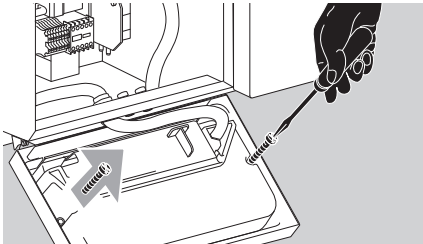

Internal connection diagram

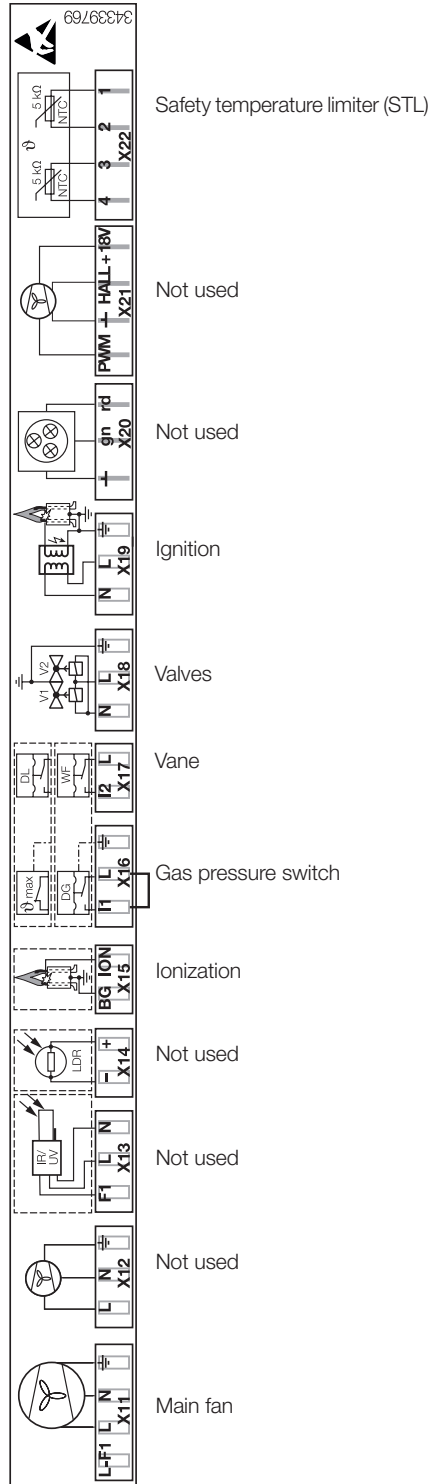

- 3** Press the RESET button to reset. The unit then reverts to the last operating mode selected.

▷ Possible faults:

Display	Fault type
F	Flame fault
R	Air fault
C	Temperature fault
E	Electronics fault
U	Other possible faults
P	Gas-related faults

- 4** If the burner control unit does not respond even though all the possible faults have been rectified as described below, contact your supplier.

? Fault

! Cause

• Remedy

? The 7-segment display has gone out despite the voltage supply being OK?

- !** Fuse F2 is defective.
- Check the fuse contacts.
There is a spare fuse directly next to the fuse holder.

Attention! Fit the correct fuse for 4 A.

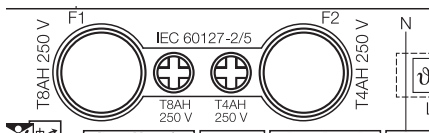

? Error code P and ! flash alternately and the light is red?

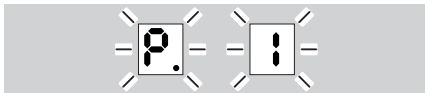

- !** Pressure switch does not switch.
 - Check inlet pressure p_U .
- !** Gas pressure on the burner too low.
 - Readjust gas pressure p_G on the combination control, see page 8 (Adjusting the heater).
- !** Fuse F2 defective.
 - Replace fuse (3.15 A, slow-acting, H). Ensure that only one heater is directly wired to the thermostat, see page 3 (Wiring).

? Error code P and 2 flash alternately and the light is red?

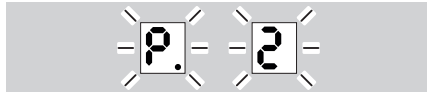

- !** During three consecutive restarts, the gas pressure switch has tripped during the safety time or flame proving period (gas pressure switch oscillates).
 - Inlet pressure fluctuates. Establish stable gas supply.
 - Gas pressure p_G too low. Readjust gas pressure p_G , see page 8 (Adjusting the heater).

? Error code R and ! flash alternately?

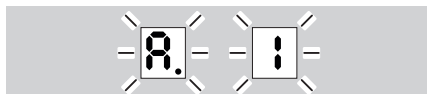

- !** Vane switch switches off during burner operation.
 - Check the function of the vane switch, see page 18 (Maintenance).
 - Vane, fan or grille are dirty. Clean, see page 18 (Maintenance).
 - Fuse F1 defective (8 A, slow-acting, H). Check the function of the fan and replace fuse F1 if necessary.
- !** Motor defective.
 - Remove the device and return it to the supplier.

? Error code R and 2 flash alternately?

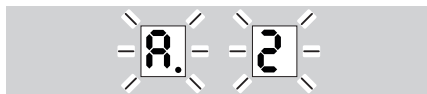

- !** Vane switch does not switch off during the “no flow” state check on burner start-up.
 - Check that the vane switch is functional, see page 18 (Maintenance).

? Error code R and 2 flash alternately and the light is red?

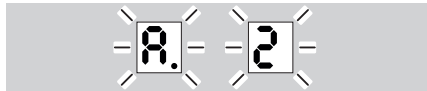

- !** The fault “Vane switch” could not be rectified. The programmed number of start-up attempts having failed, the ACU initiates a fault lock-out.
 - Reset using the RESET button on the ACU or via the remote reset.
 - Check that the vane switch is functional, see page 18 (Maintenance).

? Error code *R* and *3* flash alternately?

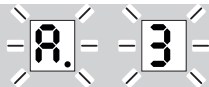

! The vane switch has not switched on 15 s after the fan has been switched on.

- Vane, fan or grille are dirty. Clean, see page 18 (Maintenance).
- Fuse F1 defective (8 A, slow-acting, H). Check the function of the fan and replace fuse F1 if necessary.
- ! Motor defective.
- Remove the device and return it to the supplier.

? Error code *R* and *3* flash alternately and the light is red?

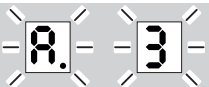

! The fault could not be rectified. The programmed number of start-up attempts having failed, the ACU initiates a fault lock-out.

- Reset using the RESET button on the ACU or via the remote reset.
- Check that the vane switch is functional. Clean the vane, fan or grille if soiled.

? Error code *F* and *!* flash alternately?

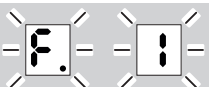

! On burner start-up, the ACU has not detected a flame during the safety time. In the parameter "Number of start-up attempts", it is possible to program up to three start-up attempts. If one of the further start-up attempts is successful, warning signalling stops automatically once the post-purge time has elapsed.

- ! Ignition is not working properly.
- Clean the spark electrode and check for correct distance, see page 18 (Maintenance).
- Check the connection of the ignition cables for damage or moisture.
- ▷ The spark plug must be fitted correctly.
- Check the ignition spark optically and acoustically from the fan side during the 4-second ignition time.
- ! Poor flame signal due to incorrect burner adjustment.
- Readjust gas pressure p_G , see page 8 (Adjusting the heater).
- ! Poor flame signal due to dirty/badly connected flame rod.
- Clean the flame rod and check for correct distance, see page 18 (Maintenance).

- Check the cable connection, cable and terminal boot for damage or moisture. The terminal boot must be fitted correctly.

- Check the yellow and green burner ground cable for corrosion and to ensure it is firmly connected.

! Air in the gas pipe.

- Vent the gas pipe.

! Valves do not open.

- Remove the valve plug on the combination control CG and measure the voltage between L1 and N during the safety time. If the voltage is not adequate, first replace the CG and return it to the supplier.

Attention! Only commission the new ACU once the short-circuit or fault on the valve output of the CG has been remedied. Otherwise, the new ACU will be damaged.

- If the fault continues to be signalled, there may be a short-circuit on the valve output. Return the burner control unit to the manufacturer for inspection.

! Short-circuit on ignition output.

- Replace fine-wire fuse F2 (3.15 A, slow-acting, H) and check the safety function, see page 20 (Checking the safety functions and burner operation).

? Error code *F* and *!* flash alternately and the light is red?

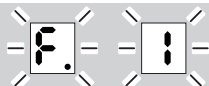

! The fault could not be rectified. The programmed number of start-up attempts having failed, the ACU initiates a fault lock-out.

- Reset using the RESET button on the ACU or via the remote reset.
- Rectify the cause of the fault as described for warning *F,!*.

? Error code *F* and *2* flash alternately?

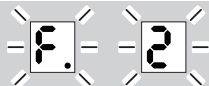

! The flame has gone out during operation. If a restart has been programmed, an automatic restart is carried out provided that the burner has been in operation for at least 2 s beforehand.

- Poor flame signal due to incorrect burner adjustment. Readjust gas pressure p_G , see page 8 (Adjusting the heater).
- Poor flame signal due to dirty or badly connected flame rod. Clean the flame rod and check for correct distance, see page 18 (Maintenance).
- Check the cable connection for damage or moisture. The terminal boot must be fitted correctly.

- Check the yellow and green burner ground cable for corrosion and to ensure it is firmly connected.

? Error code F. and 2 flash alternately and the light is red?

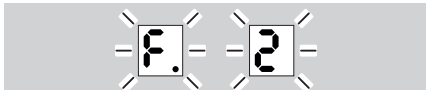

- ! The fault could not be rectified. The programmed number of start-up attempts having failed, the ACU initiates a fault lock-out.
- Reset using the RESET button on the ACU or via the remote reset.
- Rectify the cause of the fault as described for warning F.2.

? Error code F. and 3 flash alternately and the light is red?

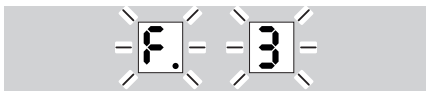

- ! The burner control unit detects a flame signal during start-up or in fault status.
 - ! A gas valve does not close correctly.
 - Shut off the gas supply to the device. Check the burner and gas valves for correct function, see page 20 (Checking the safety functions and burner operation).
 - ! Incorrect flame signal due to leakage/creepage current.
 - Check wiring, see page 3 (Wiring).
 - Check the flame rod.
 - ! Incorrect flame signal through conductive ceramic insulation, e.g. surge via PE wire, possible.
 - Remedy incorrect flame signal. Replace the flame rod and, if necessary, also the complete burner control unit and housing.
- ▷ Reset is only possible by pressing the RESET button on the burner control unit or using the remote reset if there is one.

? Error code F. and 4 flash alternately and the light is red?

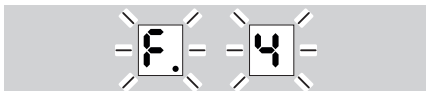

- ! The flame has not gone out within 5 s of the burner being switched off. A gas valve does not close correctly.
- Shut off the gas supply to the device. Check the burner and gas valves for correct function, see page 20 (Checking the safety functions and burner operation).

? Error code C. and 1 flash alternately and the light is red after 5 minutes?

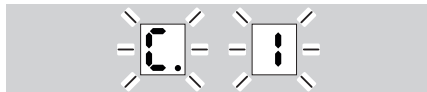

- ! Signal from safety temperature monitor (STM). Temperature has been exceeded.
- Leave heater to cool down for longer.
- ! The main fan does not switch on.
- Check the main fan.
- ! Wiring fault.
- Check the wiring to actuate the main fan, see page 3 (Wiring).
- ! The safety temperature monitor (STM) is incorrectly aligned.
- Check the position of the safety temperature monitor (STM).
- ! Ambient temperature exceeded.
- The temperature is > 40°C. Allow the room to cool.
- ! The safety temperature monitor (STM) is measuring an incorrect temperature.
- Replace the safety temperature monitor.
- ! The heater is badly soiled.
- The heater must be cleaned urgently.
- ! Installation position.
- The heater is too close to other heaters, see page 2 (Installation).
- ! Device incorrectly set.
- The heater is not set correctly and must be adjusted, see page 8 (Adjusting the heater).
- ! In the event of a power failure during operation, the heater will be switched off without a cooling phase. If the power failure lasts less than 5 minutes, the combustion chamber will heat the device and the STL will issue a signal.
- In this case, Controlled air flow mode is activated. If the heater has been successfully cooled within 1 minute, it will restart.

? Error code C. and 2 flash alternately and the light is red?

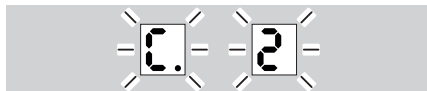

- ! Signal from safety temperature limiter (STL). Temperature has been exceeded.
- ! The cause of the fault as described above for fault C.1 could not be rectified.
- Check the heater for damage, see page 18 (Maintenance).

? Error code E and 9 flash alternately and the light is red?

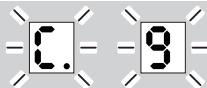

- ! Temperature sensor incorrectly connected.
- Check contact at connector X22.
- ! Temperature sensor is below -30°C.
- ! Temperature sensor defective.
- Replace temperature sensor.
- ! Incorrect temperature sensor.
- ▷ Sensor BCU is not compatible with the ACU.
- Select the correct temperature sensor for the ACU.

? Error code E and 1 flash alternately?

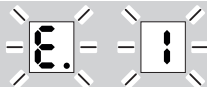

- ! The remote reset input is defective.
- If you use the remote reset input, contact your supplier.

? Error code E and 2 flash alternately and the light is red?

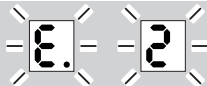

- ! An adjustable parameter and the CRC check are not the same. The parameters are implausible.
- Order a new BCC. Contact your supplier.
- ▷ Reset is only possible by pressing the RESET button on the burner control unit or using the remote reset if there is one.

? Error code E and 3 flash alternately and the light is red?

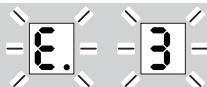

- ! A fixed parameter and the CRC check are not the same. The parameters are implausible.
- Order a new BCC. Contact your supplier.
- ▷ Reset is only possible by pressing the RESET button on the burner control unit or using the remote reset if there is one.

? Error code E and 4 flash alternately and the light is red?

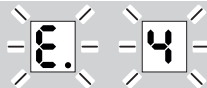

- ! Limits for fixed parameters not observed.
- Order a new BCC. Contact your supplier.

? Error code E and 5 flash alternately and the light is red?

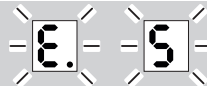

- ! The BCC is not connected.
- Connect the BCC to the printed circuit board.

? Error code E and 6 flash alternately and the light is red?

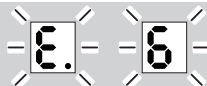

- ! An incorrect BCC is connected. The BCC must be compatible with the GP.
- Remove the BCC and connect the correct BCC to the printed circuit board, see page 6 (Burner Chip Card (BCC)).

? Error code E and 8 flash alternately?

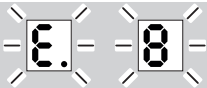

- ! Programming mode is active.
- As soon as Programming mode has been deactivated, the display will go out.

? Error code E and 9 flash alternately?

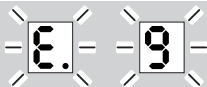

- ! Internal electronics fault.
- Remove the BCC and return it to the supplier.

? Error code U and 1 flash alternately and the light is red?

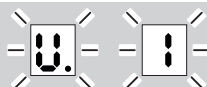

- ! Voltage supply is below the limit (programmable limit, e.g. < 160 V).
- Ensure that adequate mains voltage is supplied.

? Error code U and 2 flash alternately and the light is red?

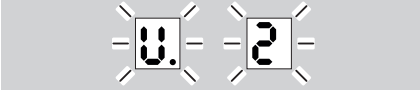

- ! Voltage supply is above the limit (programmable, e.g. > 260 V).
- Ensure that adequate mains voltage is supplied.

? Error code U and 3 flash alternately and the light is red?

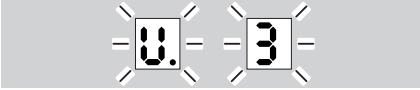

- ! All start-up attempts in the programmed voltage range (e.g. 160 – 180 V) were unsuccessful. The last start-up attempt is not made to prevent a lock-out.
- Ensure that adequate mains voltage is supplied.

? Error code U and 5 flash alternately and the light is red?

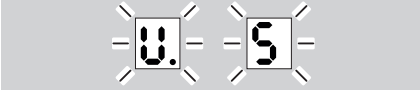

- ! While a fault was pending, the unit has been successfully reset more than 5 times within 15 minutes using the remote reset input.
- ▷ Reset is only possible by pressing the RESET button on the burner control unit or using the remote reset if there is one.

? Error code U and 6 flash alternately and the light is red?

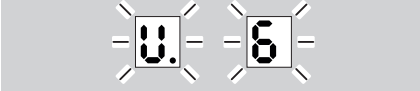

- ! The unit has been unsuccessfully reset more than 10 times within 15 minutes using the remote reset input.
- ▷ Reset is only possible by pressing the RESET button on the burner control unit or using the remote reset if there is one.

? A circulating dash is displayed rather than an error code?

- ▷ After switching on the voltage, a circulating dash is displayed.



- ! Switch-on delay time running.
Or
- ! Cycle lock active. The time (cycle lock) between two starts is too short.
- ▷ The display will go out automatically as soon as the time between two starts is long enough. The burner control unit will ensure a pause between start-up attempts on the basis of its parameterization. This warning is displayed during this time.
Or
- ! The pressure switch signal does not drop when the main fan is switched off.
- ▷ A burner restart is not possible.
- ▷ After 25 s, the display will change to error code R 9.

Maintenance

! CAUTION

To ensure that no damage occurs during operation and maintenance, please observe the following instructions. Otherwise, injuries or damage to the device may occur and/or the function of the device may be impaired. The supplier/manufacturer cannot accept liability for damage resulting thereof.

- Have the heater cleaned at least once a year by qualified maintenance personnel.
- Have the safety functions checked at least once a year by qualified maintenance personnel, see page 20 (Checking the safety functions and burner operation).
- Sharp-edged metal sheets. Always wear protective gloves.
- After cleaning or repair work, check that the components on and in the heater are in good condition. The device may only be restarted if all safety devices have been installed and the safety functions have been checked, see page 20 (Checking the safety functions and burner operation).

1 Switch off the burner control unit ACU.

2 Disconnect the system from the electrical power supply.

- ▷ The mains plug may only be pulled out once the device has been switched off and post-cooling is complete.

3 Shut off the gas supply.

- ▷ To facilitate cleaning of the components inside the housing, the service cover on the casing can be opened.

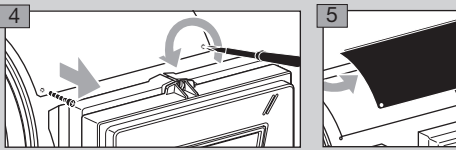

- ▷ Alternatively, the fan may be removed.

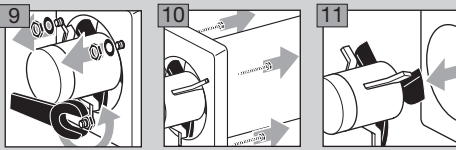
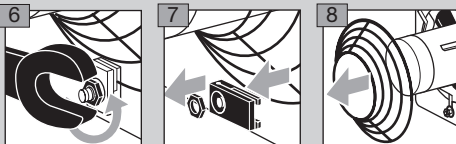

12 Clean the grille with a cloth.

13 Clean the interior of the device carefully using air.

- ▷ The vane must not be bent.

14 Clean the fan and vane using a cloth.

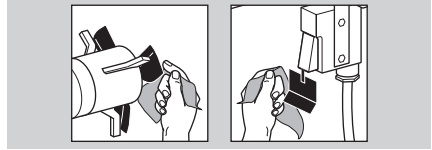

15 Check that the vane switch is functional.

- ▷ If the vane is moved a little in the direction of the arrow, a quiet click can be heard. This means that the switching path is correct.

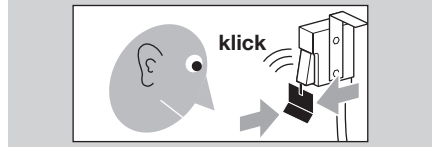

- ▷ Check the nozzle and burner baffle plate for dirt and if necessary, clean using a cloth. Remove first the burner baffle plate, then the nozzle. To do this, a special tool is required. Nozzle spanner size = A/F 36 and A/F 46. The nozzle is secured via the burner baffle plate by a cross-head screw.

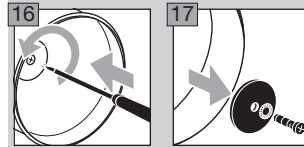

18 Loosen the A/F 36 nut to detach the gas pipe.
Note the seal.

19 Then loosen the A/F 46 nut.

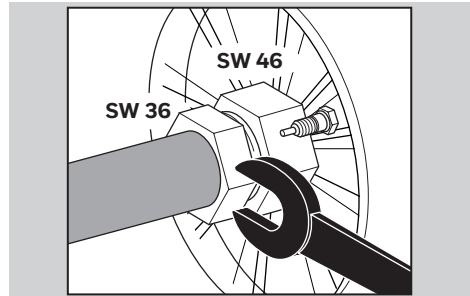

- ▷ Remove the nozzle.

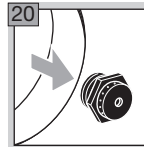

- ▷ The flame rod and spark electrode can be removed without having to dismantle the combustion chamber.

21 Check the nozzle for signs of damage and dirt and clean if required.

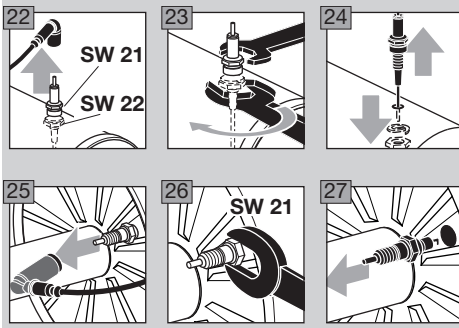

28 Check the electrodes for dirt and if necessary, clean using a cloth. Remove stubborn dirt on the electrode rod using fine abrasive paper.

29 Check electrodes and porcelain insulators for cracks and replace the electrodes in case of damage.

- ▷ Replace the electrodes if necessary.
- ▷ Fit the electrode seal.

30 Clean the plates for the air intake using a cloth.



▷ The device may only be restarted if all safety devices have been installed.

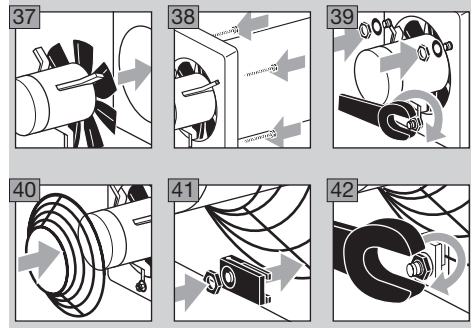

43 Check the safety functions before commissioning, see page 20 (Checking the safety functions and burner operation).

Assembly

▷ Ensure that the rubber seals between the electrodes and the terminal boots are fitted correctly.

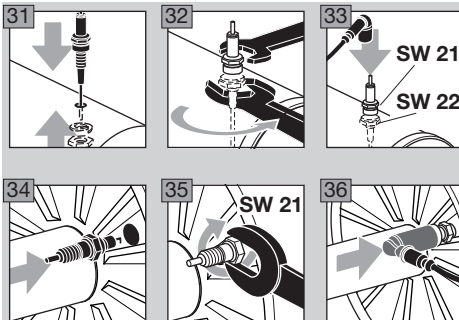

▷ Ensure the electrodes are at the correct distance from one another and correctly positioned as regards the nozzle.

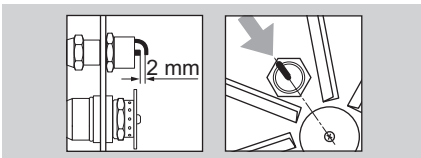

Checking the safety functions and burner operation

⚠ WARNING

If these checks are not carried out, the gas valves might remain open allowing non-combusted gas to escape. Risk of explosion!

Safety functions

- 1** Switch off the heater during operation. Press ON/OFF .
 - ▷ The flame goes out < 1 s.
 - ▷ The fan cools the heater down until it reaches switch-off temperature.
- 2** Remove the valve plug on the combination control during operation.
 - ▷ The gas valves close < 1 s.
 - ▷ The flame goes out.
 - ▷ The burner control unit ACU displays the warning message "The flame has gone out during operation". Error code F. and 2 flash alternately.
 - ▷ If a restart has been programmed, the burner control unit will initially attempt to restart and will then perform a fault lock-out. Error code F. and 1 flash and indicate the fault message "No flame has been detected during the safety time".
- 3** Shut off the inlet pressure during operation.
 - ▷ The pressure switch in the combination control switches because the supply pressure is too low.
 - ▷ The burner control unit performs a safety shutdown: the gas valves are disconnected from the electrical power supply.
 - ▷ The flame goes out.
 - ▷ The burner control unit ACU displays the fault message "Supply pressure too low". Error code P. and 1 flash alternately and the light is red.
 - ▷ If the burner control unit responds in a different way to that described, a fault has occurred, see page 12 (Assistance in the event of malfunction).

! CAUTION

The fault must be remedied before the system may be operated.

Checking burner operation

- 1** Switch on the ACU.
- 2** Select operating mode 2  Heating.
- 3** Allow the burner to burn for 15 minutes.
- 4** During this time, monitor the flame pattern.
 - ▷ The flame must be blue.
 - ▷ No dirt particles must come out of the heater.

Accessories

Room thermostat

Use a room thermostat with a hysteresis of $\pm 1^\circ\text{C}$, 230 V, Type TH 215.

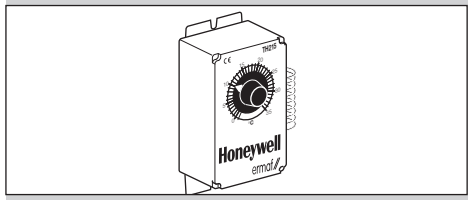

Order No.: N50260145

Pressure reducer

Pressure reducer for LPG.

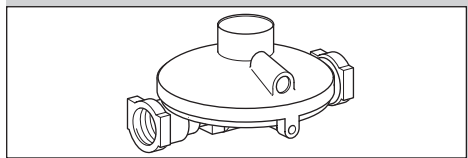

RECA 1.5 bar to 50 mbar, 2 x 1/2" internal thread connection, 10 kg/h, Order No.: N52600023.

Manual valve

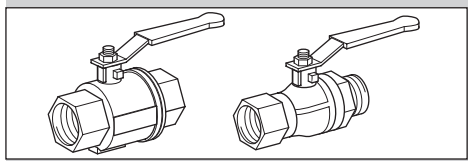

2 x 1/2" internal thread connection,

Order No.: N52600019.

1/2" internal and external thread connection,

Order No.: N52600027.

Connection kit for natural gas

Manual valve and gas hose to connect the gas combination control CG to the gas supply.

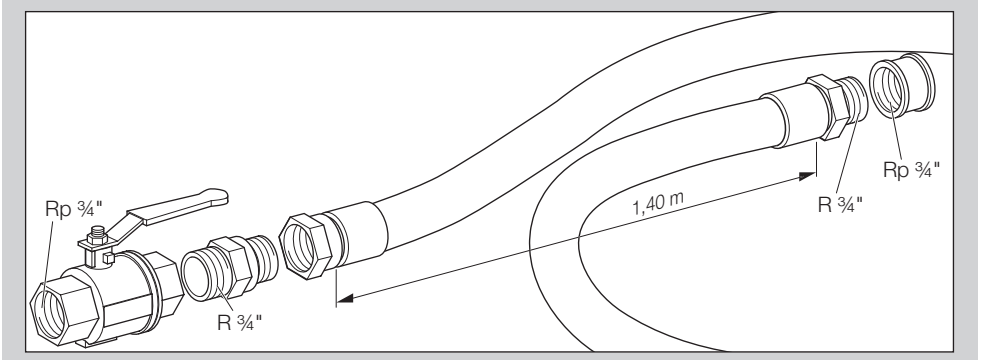

Connection kit: Rp 3/4" threaded connection, total length = 1.50 m, Order No.: N52600072

Connection kit for propane

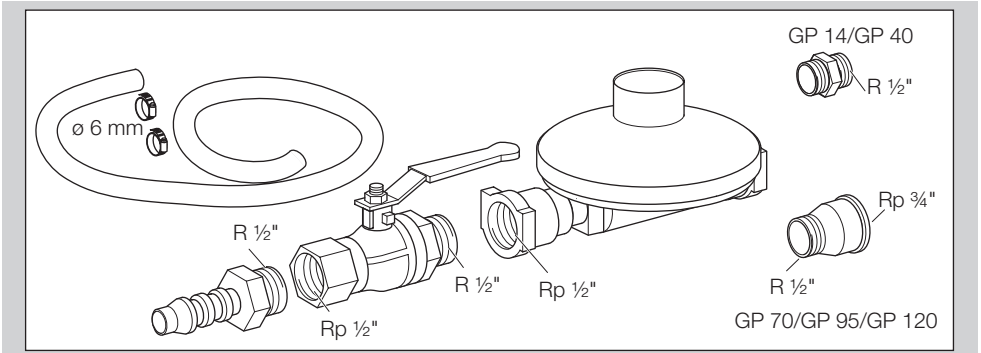

Pressure reducer, manual valve, hose (length = 2 m), 2 hose clamps, R 1/2" double nipple for GP 14/GP 40, R 1/2 - Rp 3/4" reducing fitting for GP 70 - GP 120, to connect the gas combination control CG to the gas supply, Order No.: N52600025

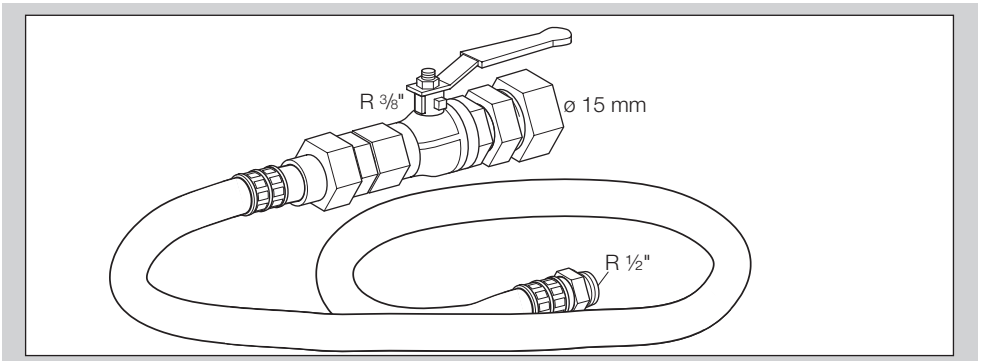

Manual valve and hose (DVGW certified, length = 2 m) to connect the gas combination control CG to the gas supply, Order No.: N52990209

Spare parts

- ▷ When ordering spare parts, please quote the order number along with the designation and item no. of the spare part as well as the heater serial number.
- ▷ When ordering spare parts which are not listed here below, please quote the edition of these operating instructions and the heater serial number.
- ▷ Use genuine spare parts only to ensure the replacement complies with the requirements stipulated by the manufacturer.

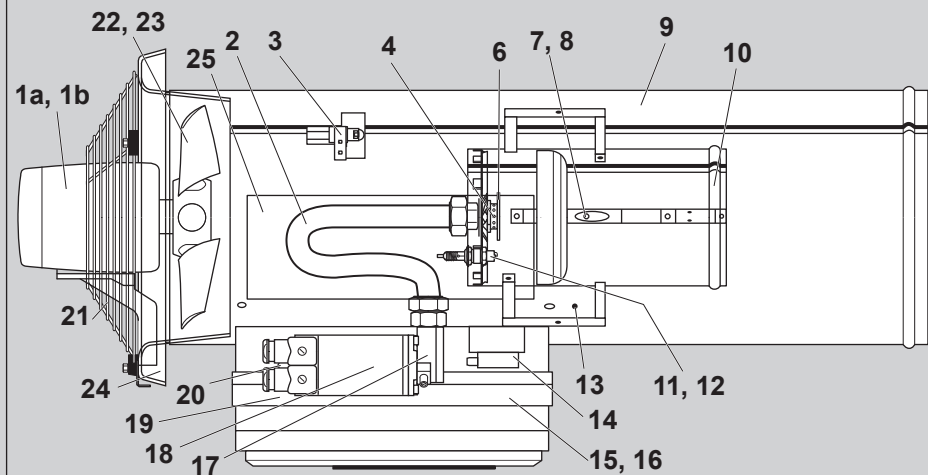

Item	Order No.	Designation
1a	N50260350	Fan motor, 50 Hz, GP 70
1b	N50260360	Fan motor, 60 Hz, GP 70
2	N70300084	Flexible connection pipe for GP 40/70
3	N70300101	Vane switch, complete, for GP 70
4	N70300055	Natural gas nozzle for GP 70 ACU
	N70300056	Propane nozzle for GP 70 ACU
6	N70300058	Burner baffle plate for GP 40/GP 70
7	N70300064	Flame rod for GP 40/GP 70
8	N70300108	Ionization cable kit for GP 40/GP 70 ACU
9		Housing for GP 70
10	N70300025	Burner chamber for GP 70
11	N70300063	Spark plug for GP 40/GP 70
12	N70300104	Ignition cable kit for GP 40/GP 70 ACU
13	N70300095	Safety temperature limiter (STL) for GP 14 – GP 120 ACU
14	N50260109	Ignition transformer for GP series
15	N70300005	ACU 121, complete
16	N70300007	Burner Chip Card (BCC) for GP series
17	N70300081	Angle flange, outlet, for GP 70 – 120
18	N70300074	Gas combination control CG 2 for GP 70 – GP 120 ACU, incl. angle flange
19	N70300088	Universal cable kit, complete, for GP ACU
20	N70300076	Angle flange, inlet, for GP 70 – 120 ACU
21	N52700002	Safety grille for GP 40/GP 70
22	N50260399	Fan impeller wheel, 50 Hz
23	N50260395	Fan impeller wheel, 60 Hz
24	N50260244	Fan inlet hood for GP 40/GP 70 ACU
25	N70300147	Cover for maintenance opening, for GP 40/GP 70 ACU

Technical data

Gas types: I12ELL3B/P,
natural gas H and L (gases of category 2);
LPG, gaseous (gases of category 3): propane,
propane/butane, butane.
NOx Class: depending on gas type up to Class 5.
Inlet pressure p_U : 20 to 70 mbar.
Resistant to high-pressure cleaning.
Gas connection: R $\frac{3}{4}$ to ISO 7-1.
Staged control: On/Off signal (240 V AC or
24 V AC/DC via coupling relay).
Burner control unit with direct spark ignition and
ionization control.
Fan type:
main fan: axial.
Material:
housing: stainless steel,
combustion chamber: stainless steel,
burner control unit: flame-retardant polymer blend
made of polycarbonate (PC) and acrylonitrile
butadiene styrene copolymer (ABS).
Ambient temperature $T_{max.} \leq 40^\circ\text{C}$,
temperature differential $\Delta T_{max.} \leq 35^\circ\text{C}$,
example for calculating the jet temperature:
 $T + \Delta T = 40^\circ\text{C} + 35^\circ\text{C} = 75^\circ\text{C}$.
Storage temperature: -20 to +50°C.
Cycle lock: 15 s.
Capacity: 70 kW.
Jet length: 50 m,
velocity at the jet end: 0.5 m/s.
Gas consumption:
natural gas L: 7.6 m³/h,
natural gas H: 6.5 m³/h,
propane: 4.5 kg/h,
butane: 5.3 kg/h.
Connection rating:
230 V AC, -15/+10%, 50 Hz, 445 W.
Current consumption I_N : 1.9 A.
Air circulation:
controlled air flow: ± 3875 m³/h,
heating: ± 4500 m³/h.
Dimensions: 1200 x 600 x 440 mm.
Sound level: ≤ 68 dB.
Weight: 28 kg.

The Netherlands

The device has been designed for equipment category K (I2K) and is suitable for use with distribution gases G- and G+ in accordance with the specifications set out in NTA 8837:2012, Annex D, with a superior Wobbe index of 43.46 – 45.3 MJ/m³ (dry, 0°C) or 41.23 – 42.98 (dry, 15°C).
In addition, this device can be converted to equipment category E (I2E) and/or calibrated.

This means the device is "suitable for G+ gas and H gas or proven to be suitable for G+ gas and proof has been provided that it can be converted for use with H gas" as defined by the "Dutch Decree of 10 May 2016 regarding amendment of the Dutch Gas Appliances Decree ...".

Declaration of conformity



We, the manufacturer, hereby declare that the product GP complies with the requirements of the listed Directives and Standards.

Directives:

- 2014/30/EU – EMC
- 2014/35/EU – LVD

Regulation:

- (EU) 2016/426 – GAR

Standards:

- EN 525:2009
- EN 60335-1:2012
- EN 60335-2-102:2016
- EN 55011:2016
- EN 61000-6-2:2016
- EN 50465:2015

The relevant product corresponds to the tested type sample.

The production is subject to the surveillance procedure pursuant to Regulation (EU) 2016/426 Annex III, No. 2, Module C2.

Elster-Instromet B.V.

Scan of the Declaration of conformity (D, GB) – see www.docuthek.com

Logistics

Transport

Protect the unit from external forces (blows, shocks, vibration). On receipt of the product, check that the delivery is complete, see page 2 (Part designations). Report any transport damage immediately.

Storage

Store the product in a dry and clean place.
Storage temperature: see page 23 (Technical data).
Storage time: 6 months before using for the first time. If stored for longer than this, the overall service life will be reduced by the corresponding amount of extra storage time.

Packaging

The packaging material is to be disposed of in accordance with local regulations.

Disposal

Components are to be disposed of separately in accordance with local regulations.

Goods return form

Name of the operator

P.O. Box/Street

Postcode and town/city

Tel.

E-mail

 Returned by (Mr./Ms.)

Date

Number of returns

Heater serial number

Power supply [V/Hz]

Inlet pressure p_u [bar]

Reasons for return

Description of fault

Desired action

Credit note

Replacement

Repair

Remarks

Date and signature

Please send returns back to your supplier.

Contact

Honeywell

Elster s.r.o.
Nám. Dr. A. Schweitzera 194
916 01 Stará Turá
Slovakia
Tel. +421 32 775 26240
Fax +421 32 776 2658
orders.ermaf@elster.com, www.ermaf.nl

We reserve the right to make technical modifications
in the interests of progress.