

Operating instructions

Heater GP 95



Translation from the German
 © 2013 Elster-Instromet B.V.

Contents

Heater GP 95	1
Contents	1
Safety	1
Checking the usage	2
Type code	2
Part designations	2
Type label	2
Installation	2
Tightness test	3
Removing the protective caps (optional)	3
Wiring	3
Connecting the room thermostat for "Heating" and "Controlled air flow" mode	4
Connecting multiple heaters to a single room thermostat	5
Reset, alarm, external fan	5
Adjusting the switch-on delay t_E	5
Commissioning	6
Adjusting the heater	6
Installing the protective caps	7
Cleaning	8
Assistance in the event of malfunction	9
Maintenance	12
Checking the safety functions and burner operation	14
Accessories	14
Spare parts	16
Technical data	17
Declaration of conformity	17
Goods return form	18
Contact	18

Safety

Please read and keep in a safe place



Please read through these instructions carefully before installing or operating. Following the installation, pass the instructions on to the operator. This unit must be installed and commissioned in accordance with the regulations and standards in force. These instructions can also be found at www.docuthek.com.

Explanation of symbols

■, **1**, **2**, **3**... = Action
 > = Instruction

Liability

We will not be held liable for damage resulting from non-observance of the instructions and non-compliant use.

Safety instructions

Information that is relevant for safety is indicated in the instructions as follows:

DANGER

Indicates potentially fatal situations.

WARNING

Indicates possible danger to life and limb.

! CAUTION

Indicates possible material damage.

Maintenance and repairs may only be carried out by qualified gas technicians and electrical interventions may only be carried out by qualified electricians.

Conversion, spare parts

All technical changes are prohibited. Only use OEM spare parts.

Transport

On receipt of the product, check that the delivery is complete (see page 2 (Part designations)). Report any transport damage immediately.

Storage

Store the product in a dry place. Ambient temperature: see page 17 (Technical data).

Changes to edition 11.12

The following chapters have been changed:

- Checking the usage
- Installation
- Accessories
- Technical data
- Contact

Checking the usage

GP 95

Heater with direct, open combustion for agricultural stables and horticultural greenhouses. Depending on the type and setting, the heater can be operated with natural gas or LPG (propane/butane).

This function is only guaranteed when used within the specified limits – see page 17 (Technical data). Any other use is considered as non-compliant.

Type code

Code	Description
GP	Heater
95	Capacity 95 kW, jet length 40 m

Part designations

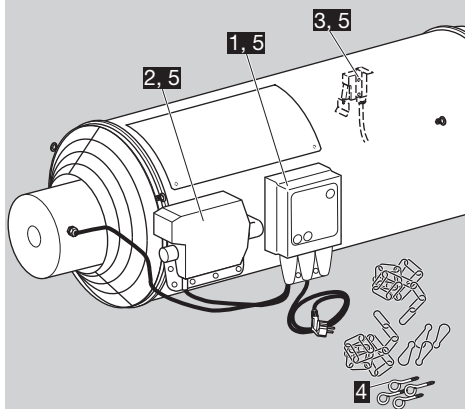

- 1 Burner control unit BCU
- 2 Gas combination control CG
- 3 Vane
- 4 Assembly accessories
- 5 Protective cap set for use in agriculture (option)

Type label

Air circulation, electrical connection rating, voltage, rated heat input, gas type, category, supply pressure, burner pressure, enclosure: see type label.



- Before installation, check whether the device is suitable for the regional gas type and the specified limits, see type code and page 17 (Technical data).

Installation

⚠ DANGER

Danger of death! Gases are generated during the storage of slurry which remain partly dissolved in the liquid. If the slurry is strongly agitated during mixing and purging, poisonous, explosive gases such as hydrogen sulphide and methane are released. If an ignition source is present, the released gas can explode.

To avoid damage during operation, please observe the following:

- Switch off the heater before mixing and purging the slurry.
- Close the slide valves when storing slurry outside.
- The fan for the air supply must not be part of a closed pipe system.
- The space to be heated must be adequately ventilated.
For mechanical extraction equipment: at least 10 m³/h of air per installed capacity.
In the case of natural ventilation, the structure must have two apertures with a free opening area of 60 x B in cm². "B" is the installed capacity in kW. Replacement of the full air volume per hour is thus ensured.
- In the case of natural ventilation, the maximum allowable total capacity of the heater is 1 kW per 20 m³ of volume.
- Respect the safety distance of the heater to inflammable materials, see "Installation position".
- Consult your fire insurance provider and/or local fire protection engineer to assess the foreseeable, general risk of fire.
- For cleaning, care and maintenance, note the applicable national regulations and directives.
- No condensation permitted. Check the ambient temperature, see page 17 (Technical data).

Installation position

- ▷ To ensure that the vane functions faultlessly, install the unit in the horizontal position.
- ▷ Note the safety distance to walls and inflammable materials.

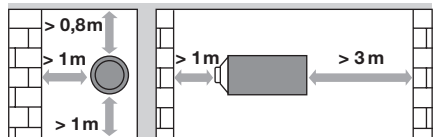

- ▷ Ensure sufficient free space around the device. There must be no obstructions in front of the inlet and outlet side of the heater.
- ▷ To avoid overheating, do not cover the electric motor.

Connecting the gas supply

- ▷ If the heater is suspended on chains, use an approved flexible gas hose.
- 1** Disconnect the system from the electrical power supply.
- 2** Shut off the gas supply.
- 3** Remove the screw plug at the inlet tube of the gas combination control CG.
- 4** Connect the gas pipe with threaded connection (Rp 3/4" internal thread) or gas hose, see page 14 (Accessories), to the inlet tube of the gas combination control.
- ▷ Use approved sealing material only.
- ▷ Note the maximum inlet pressure, see page 17 (Technical data).

Tightness test

- ▷ The system is disconnected from the electrical power supply. The valves are thus closed.

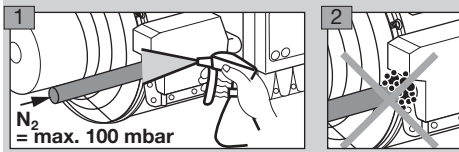

Removing the protective caps (optional)

- ▷ For agricultural use, the burner control unit, gas combination control and vane switch are mostly protected against ingress of dirt and moisture by a cap.
- ▷ To wire the burner control unit and to start and adjust the heater, the protective caps are to be removed as described below.
- ▷ Do not remove the protective cap on the vane switch.

Burner control unit

- 1** Slowly pull apart the ends of the protective cap on the back of the burner control unit until the rivets come undone.

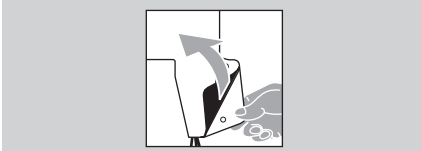

- 2** Pull the opened edges of the protective cap fully so that the edges are pulled out from between the burner control unit and the mounting plate.

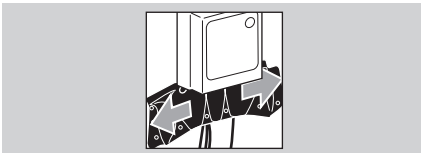

- 3** Remove the opened protective cap from the burner control unit by pulling it upwards.



Gas combination control

- 1** Slowly pull apart the ends of the protective cap on the underside until all the rivets come undone.

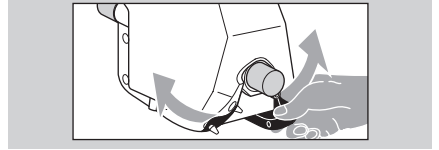

- 2** Starting on the right-hand side, pull the opened protective cap upwards over the gas outlet.

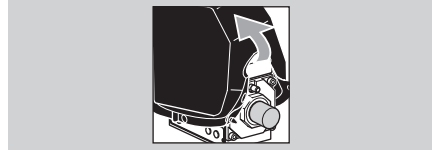

- 3** Remove the protective cap completely by pulling over the left-hand side of the gas inlet.

Wiring

! CAUTION

Danger of electric shocks!

- Before working on possible live components, ensure the unit is disconnected from the power supply.
- 1** Disconnect the system from the electrical power supply. The mains plug may only be pulled out once the device has been switched off.
- 2** Shut off the gas supply.
- ▷ If there is a protective cap on the burner control unit, this must first be removed.
- ▷ When opening the burner control unit, do not incline the upper housing section during its removal to prevent the plug connectors from being bent.

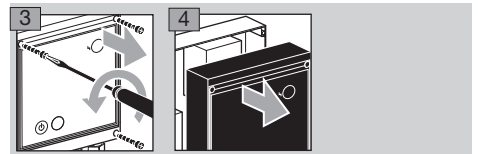

Burner control unit BCU connection diagram

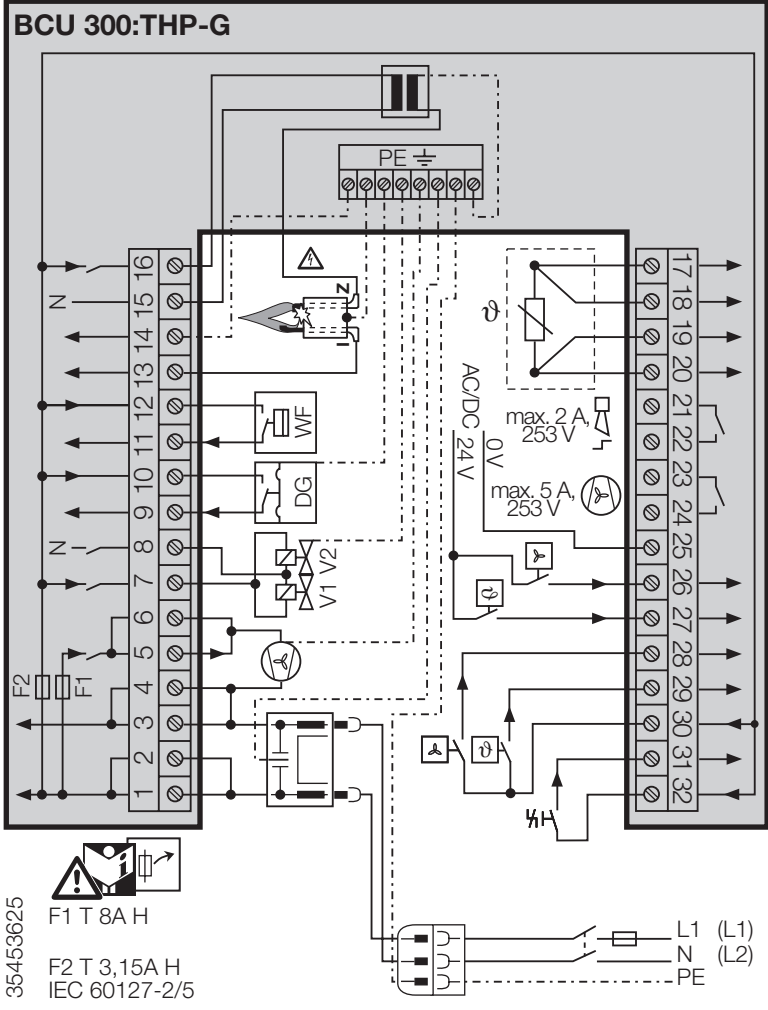

- ▷ In order to ensure post-cooling, the heater constantly requires 230 V AC.

Connecting the room thermostat for "Heating" and "Controlled air flow" mode

- ▷ Use a room thermostat with a hysteresis of $\pm 1^\circ\text{C}$. It switches on if the room temperature is 1°C less than the set temperature and switches off again once the room temperature is 1°C more than the set temperature.
- ▷ Do not directly connect the room thermostat to terminals 1 and 3.

- 5** Connect the terminals for Controlled air flow and Heating .

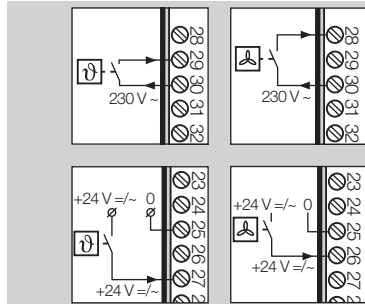

Connecting multiple heaters to a single room thermostat

- ▷ Phase reversal will result in a short-circuit.
- ▷ Do not install different phases of a three-phase current system at the inputs if the voltage between the phases exceeds 230 V (+ 10%).
- ▷ Multiple heaters must be wired to the thermostat via a relay.

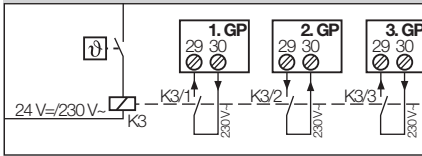

- ▷ At 24 V DC/AC, multiple heaters can be controlled in parallel.
- ▷ Note the polarity!

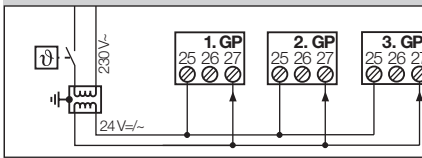

- ▷ Do not directly connect the thermostat to multiple heaters.
- ▷ Do not connect terminals 28, 29 and 30 directly to the next heater. A short-circuit can occur due to different phases and polarities.

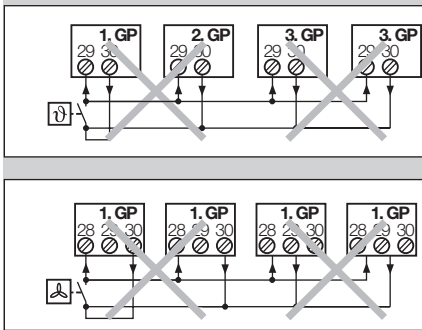

Reset, alarm, external fan

- ▷ For external fault signalling, an external alarm and an external reset button can be connected.

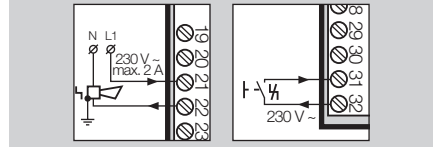

- 6 For improved air circulation in the room, an additional fan can be connected.

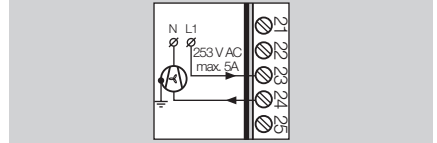

- ▷ In case of a power failure, an emergency power supply unit should automatically take over the power supply. Emergency power supply units with a cardan shaft drive for tractor attachment are also suitable.

Adjusting the switch-on delay t_E

- ▷ If multiple heaters switch on at the same time, there can be a gas and/or power shortage on individual devices. To avoid this happening, adjust the switch-on delay t_E using the potentiometer in the upper housing section of burner control unit BCU.
- ▷ The potentiometer is set to 0 s at the factory.



- ▷ We recommend using a switch-on delay t_E of 5 to 10 s between each device.
- ▷ The post-cooling time t_N is set to 50 s at the factory and the minimum burner on time t_M to 0 s. These values must not be changed.
- ▷ Once the wiring is complete, close the BCU again. Ensure that the upper housing section is not inclined when being replaced on the lower housing section.

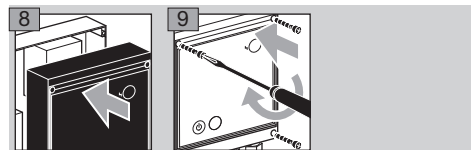

- ▷ To guarantee that the burner control unit complies with enclosure IP 54, make sure that the screws are tightly secured after wiring and that the cable glands are closed.

10 Switch on the power supply.

11 Release the gas supply.

Commissioning

- ▷ The heater may only be commissioned once it has been ensured that the heater, gas pipes, mains voltage supply and room thermostat have been installed by authorized, trained personnel according to the regulations.



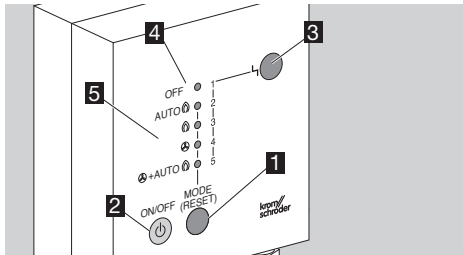

- 1 Switch on the power supply.
- 2 Release the gas supply.

Part designations



- 1 MODE/RESET selection button
- 2 BCU On/Off switch
- 3 Red lamp lights up if a fault is pending
- 4 Operating mode LED: Off
- 5 LEDs for selectable operating modes

- ▷ The BCU is operated using two buttons: using the ON/OFF button , the heater is switched on and off. By pressing the MODE selection button for > 1 s, it is possible to switch between the different operating modes.

Operating mode	Explanation
AUTO 	BCU waits for the signals for controlled air flow or heating.
	Heating (continuous operation)
	Controlled air flow (continuous operation)
 + AUTO 	Controlled air flow (continuous operation) and heating when thermostat signal is applied

Switching on

- 3 Switch on the burner control unit. Press ON/OFF  until an LED lights up.
- ▷ The BCU switches on in the last operating mode selected.
 - ▷ The heater starts once the set switch-on delay time t_E has elapsed, see page 5 (Adjusting the switch-on delay t_E).
 - ▷ The burner starts after the safety time of 5 s has elapsed and operates in the selected operating mode.
 - ▷ The operating mode can be changed using the MODE selection button. The selected operating mode is only activated once the device has been in this position for at least 3 s. It is thus possible to “scroll” through the different operating modes.

Switching off

- 4 Switch off the heater. Press ON/OFF . The LED next to “OFF” lights up and the burner switches off after 3 s. Mains voltage is still supplied however.
- ▷ The fan cools the heater down until it reaches switch-off temperature.

Faults

- ▷ Flashing LEDs signal the cause of a fault, see page 9 (Assistance in the event of malfunction).
- ▷ In the first 4 s after switching on the power supply or pressing the ON/OFF button , an operating mode is not yet active. Within these 4 s, a new operating mode can be selected. As soon as the MODE selection button has been pressed and a new operating mode has been selected, the 4 s are extended accordingly.
- ▷ If a fault has occurred, it is displayed immediately, but 4 s are also available here during which a new operating mode can be selected.

Adjusting the heater

Burner gas pressure p_G

p_U = Inlet pressure

p_G = Gas pressure on the burner

- ▷ The gas pressure on the burner is adjusted using p_G on the combination control.

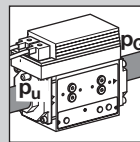

- ▷ For this, the outlet pressure p_G must be measured on the combination control.

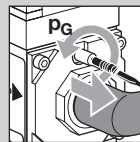

- 1 Disconnect the system from the electrical power supply. The mains plug may only be pulled out once the device has been switched off and post-cooling is complete.
- 2 Shut off the gas supply.
- 3 Open the test nipple.

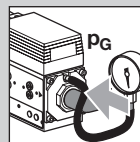

- 4 Connect a pressure gauge with display range 10 to 50 mbar.



- 5 Switch on the power supply.

- 6** Release the gas supply.
- ▷ The inlet pressure p_i must comply with the technical data, see page 17 (Technical data).
- 7** Switch on the burner control unit. Press the ON/OFF button  until an LED lights up.
- 8** Select the Heating  operating mode.
- 9** Let all heaters burn for at least 20 s.
- ▷ The required gas pressure on the burner depends on the lower calorific value/Wobbe index.
- 10** Select the required gas pressure on the burner from the table.

	Lower calorific value [MJ/m ³]	Wobbe index	[mbar]
Natural gas L G 25	32.49	41.53	12.7
Natural gas H G 20	37.78	50.71	8.0
LPG G 30	125.81	87.34	21.6

- ▷ Converting the lower calorific value/Wobbe index to kWh/m³:

$$\text{kWh/m}^3 = \frac{\text{Lower calorific value/Wobbe index [MJ/m}^3\text{]}}{3.6}$$
- ▷ Always use a pressure gauge to adjust the burner gas pressure. The white scale on the adjusting screw may differ.
- 11** If all heaters are heating at the same time, compare the required gas pressure on the burner with the gas pressure p_G read off the pressure gauge, adjust it and monitor the pressure gauge.

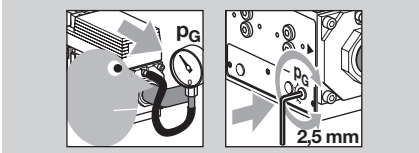





Flame signal

- ▷ The flame signal is displayed for 20 s.
- 12** Check the flame signal.
- ▷ For adjustment and maintenance work, the flame signal can be displayed.
- ▷ Display of the flame signal starts when the selection button is pressed and within 1 s (almost simultaneously), ON/OFF  is pressed, too.

● = LED is constantly lit

○ = LED flashes

	2	3	4	6	8	10	12	14	16	18	20
OFF ○ 1										○	●
AUTO  2										○	●
 3										○	●
 4										○	●
 5	○	●	●	●	●	●	●	●	●	●	●

- ▷ The flame signal is sufficient when 2 LEDs are constantly lit and the third LED flashes.
- ▷ If the flame signal is not sufficient, see page 9 (Assistance in the event of malfunction).

13 Monitor combustion.

- ▷ The flame must be blue and must remain inside the device.
- ▷ If the burner pressure p_G and flame signal have been checked and adjusted on all devices, the system operates correctly.

14 Remove the pressure gauge.

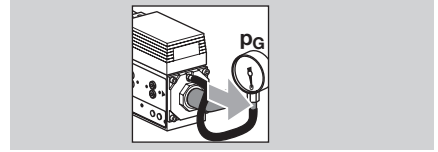

15 Close the test nipple.

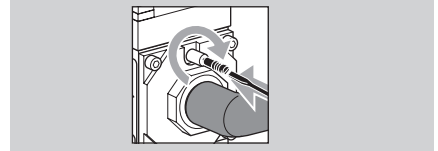

Installing the protective caps

Burner control unit

- 1** Pull the opened protective cap from the top over the burner control unit. In doing so, pull the edges of the protective cap apart.

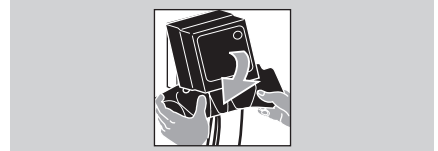

- 2** Slide the opened edges of the protective cap into the gap between the burner control unit and the mounting plate.

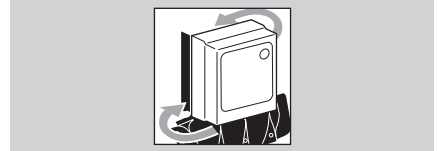

- ▷ When it becomes difficult to move the edges of the protective cap, this means the material has turned cold and hard. The protective cap will become soft again when it is heated briefly.

- 3** Hold the ends of the protective cap on the back of the burner control unit together and close the push-in rivets.



Gas combination control

- 1 First, pull the opened protective cap over the gas inlet on the gas combination control.

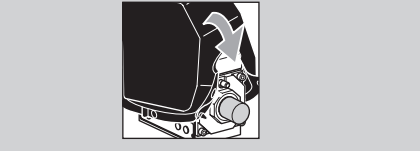

- 2 Then pull the right-hand side of the protective cap over the gas outlet.

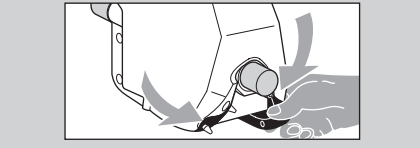

- 3 Hold together the ends of the protective cap on the underside and close all the rivets.

Cleaning

! CAUTION

To ensure that no damage occurs during operation and cleaning, please observe the following instructions. Otherwise, injuries or damage to the device may occur and/or the function of the device may be impaired, and the manufacturer's warranty will be cancelled.

- Sharp-edged metal sheets. Always wear protective gloves.
- After cleaning, check that the components on and in the heater are in good condition. The device may only be restarted if all safety devices have been installed and the safety functions have been checked.
- Clean the heater once a year when used in horticulture and at regular intervals as well as after each fattening period when used in agriculture, as described below. Inadequate or irregular cleaning can cause damage to the device or lead to fire damage. For example, dirt particles can catch fire and can be blown out of the device.

- 1 Switch off the burner control unit BCU.
- 2 Disconnect the system from the electrical power supply. The mains plug may only be pulled out once the device has been switched off and post-cooling is complete.
- 3 Shut off the gas supply.

- ▷ If the burner control unit and the gas combination control are not equipped with protective caps, we recommend cleaning the heater with compressed air or a damp cloth only.

- ▷ Equipping the burner control unit BCU and the gas combination control CG with a protective cap allows the devices to be cleaned carefully with a water jet/high-pressure cleaner during cleaning/disinfection of the animal shed.
- ▷ To guarantee that the burner control unit complies with enclosure IP 54, make sure that the screws are tightly secured after wiring and that the cable glands are closed.
- ▷ The distance between the nozzle and the surface to be cleaned must always be at least 50 cm.

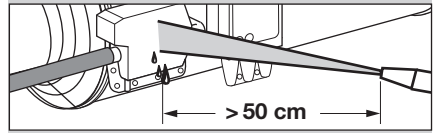

- ▷ Do not direct the water jet straight at electrical components such as the vane.
- ▷ The water jet from the high-pressure cleaner can cause serious damage to the components in the heater. For example, the vane can be bent or other parts such as the spark plug or rubber seals can be displaced. Avoid direct contact.
- ▷ Do not spray the edges of the protective cap which are closed using push-in rivets only or the connection between the burner control unit and the mounting plate directly with water, high-pressure cleaning equipment or chemical cleaning agents.



- ▷ Do not spray water or chemical cleaning agents directly into the space between the fan shaft/impeller wheel and motor and do not clean with high-pressure cleaners.

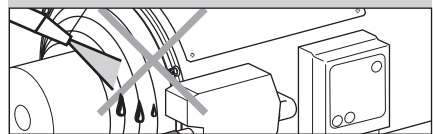

- ▷ Chemical cleaning agents, disinfectants and/or pesticides contain corrosive substances which can even corrode stainless steel. Always rinse the devices with water after cleaning using such agents to remove any residue of these agents from the surface.

- ▷ To facilitate cleaning of the components inside the housing, the maintenance cover on the casing can be opened.

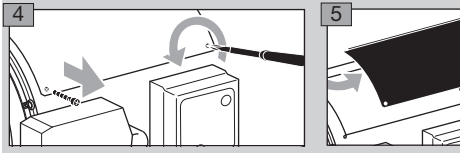

- 6** Clean the grille from the outside using a cloth.
- ▷ Clean the fan, vane and plates for the air intake using a cloth only.

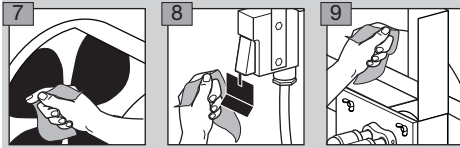

- 10** Clean the interior of the device carefully using air.
- ▷ The vane must not be bent.
- 11** Check that the vane switch is functional.
- ▷ If the vane is moved a little in the direction of the arrow, a quiet click can be heard. This means that the switching path is correct.

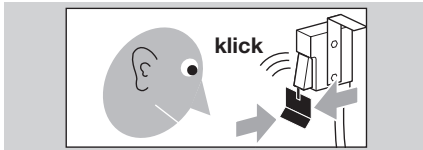

Assembly

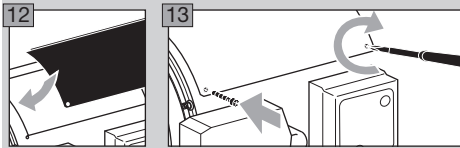

- ▷ Check the burner is functioning faultlessly in normal operation, see page 14 (Checking the safety functions and burner operation).
- 14** When operating with propane, check that the breather orifice of the pressure reducer on the connection kit is clean.

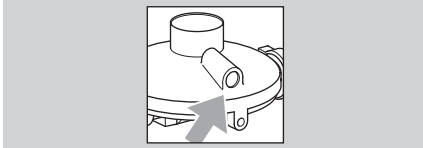

Assistance in the event of malfunction

⚠ WARNING

To avoid harm to persons and animals or damage to the heater, please observe the following:

- Electric shocks can be fatal! Before working on possible live components, ensure the unit is disconnected from the power supply.
 - Fault-clearance must only be undertaken by authorized, trained personnel!
 - Repairs to components, e.g. the burner control unit BCU or the combination control CG, may only be carried out by the manufacturer. Otherwise, the guarantee will be cancelled. Unauthorized repairs or incorrect electrical connections, e.g. the connection of power to outputs, can cause gas valves to open and the burner control unit to become defective. In this case, fail-safe operation can no longer be guaranteed.
 - (Remote) resets may only be conducted by authorized personnel with continuous monitoring of the devices concerned.
- ▷ In the event of an installation fault, the burner control unit closes the gas valves and the red LED on the burner control unit lights up. Then, the fault is indicated by a combination of flashing yellow LEDs which are numbered from 1 to 5.
 - ▷ Faults may be cleared only using the remedies described below.
- 1** Press the reset button on the BCU to reset it. The unit then reverts to the last operating mode selected.
- ▷ Faults marked with an * are warnings. Provided that a restart has been programmed, they are no longer displayed if the cause of the fault has been remedied. It is not necessary to press the reset button when these messages are displayed.
- 2** If the burner control unit does not respond even though all faults have been remedied, remove the unit and return it to the supplier.

- ? **Fault**
- ! **Cause**
- **Remedy**

Possible faults and suggested solutions

? LED 1 flashes.

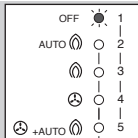

- ! Pressure switch does not switch.
- Check inlet pressure p_U .
- ! Gas pressure on the burner too low.
- Readjust gas pressure p_G on the combination control, see page 6 (Adjusting the heater).
- ! Fuse F2 defective.
- Replace fuse (3.15 A, slow-acting, H). Ensure that only one heater is directly wired to the thermostat, see page 3 (Wiring).

? LED 2 flashes.

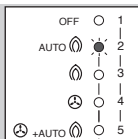

- ! Vane switch does not switch off during the “no flow” state check on burner start-up.
- Check that the vane switch is functional, see page 12 (Maintenance).

? LED 3 flashes.

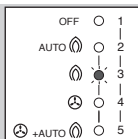

- ! The vane switch has not switched on 25 s after the fan has been switched on.
- Vane, fan or grille are dirty. Clean, see page 12 (Maintenance).
- Fuse F1 defective (8 A, slow-acting, H). Check the function of the fan and replace fuse F1 if necessary.
- ! Motor defective.
- Remove the device and return it to the supplier.

? LED 4 flashes.*

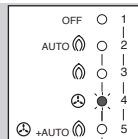

- ! On burner start-up, the BCU has not detected a flame during the safety time. In the parameter “Number of start-up attempts”, it is possible to program up to three start-up attempts. If one of the further start-up attempts is successful, fault signalling stops automatically once the post-purge time has elapsed.
- Ignition is not working properly. Clean the ignition electrode and check for correct distance, see page 12 (Maintenance). Check the connection of the ignition cables for damage or moisture. The spark plug must be fitted correctly. Check the ignition spark optically and acoustically from the fan side during the 4-second ignition time.
- Poor flame signal due to incorrect burner adjustment. Readjust gas pressure p_G , see page 6 (Adjusting the heater).
- Poor flame signal due to dirty/badly connected ionization electrode. Clean the ionization electrode and check for correct distance, see page 12 (Maintenance). Check the cable connection, cable and plug for damage or moisture. The plug must be fitted correctly. Check the yellow and green burner ground cable for corrosion and to ensure it is firmly connected.
- Air in the gas pipe. Vent the gas pipe.
- Valves do not open. Remove the valve plug on the combination control CG and measure the voltage between L1 and N during the safety time. If the voltage is not adequate, first replace the CG and return it to the supplier. **Attention!** Only commission the new BCU once the short-circuit or fault on the valve output of the CG has been remedied. Otherwise, the new BCU will be damaged.
- If the fault continues to be signalled, there may be a short-circuit on the valve output. Return the burner control unit to the manufacturer for inspection.
- Short-circuit on ignition output. Replace fine-wire fuse F2: 3.15 A (slow-acting, H) and check the safety function, see page 14 (Checking the safety functions and burner operation).

? LED 5 flashes.

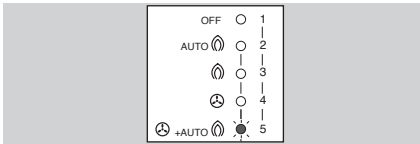

- ! Signal from safety temperature limiter (STL). Temperature has been exceeded.
- No fan run-on due to soiling. Clean, see page 12 (Maintenance).
- ! Fan defective.
- Check function of fan.

? LEDs 4 and 5 flash.*

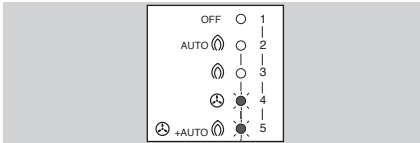

- ! Signal from safety temperature monitor (STM). Temperature has been exceeded.
- Leave heater to cool down for longer.
- No fan run-on due to soiling. Clean, see page 12 (Maintenance).

? LEDs 3 and 5 flash.*

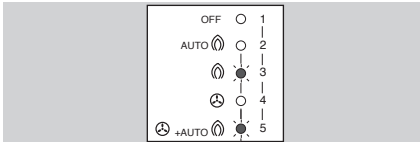

- ! During three consecutive restarts, the gas pressure switch has tripped during the safety time or flame proving period (gas pressure switch oscillates).
- Inlet pressure fluctuates. Establish stable gas supply.
- Gas pressure p_G too low. Readjust gas pressure p_G , see page 6 (Adjusting the heater).

? LEDs 2 and 5 flash.

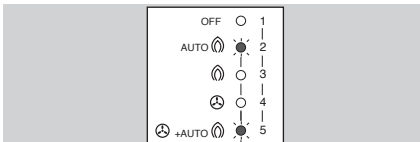

- ! Incorrect flame signal through conductive ceramic insulation, e.g. surge via PE wire, possible.
- Remedy incorrect flame signal. Replace ionization electrode and, if necessary, the BCU as well.

? LEDs 1 and 5 flash.*

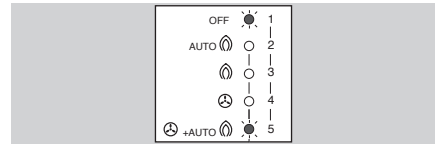

- ! Temperature sensor is not functioning correctly.
- Check the temperature sensor connection.
- Temperature sensor is below -20°C .
- ! Temperature sensor defective.
- Replace the temperature sensor.

? LEDs 3 and 4 flash.*

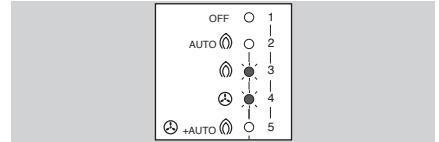

- ! The time (cycle lock) between two starts is too short.
- The BCU ensures there is a pause of 15 s between the starts. This warning is displayed during this time.

? LEDs 2 and 4 flash.*

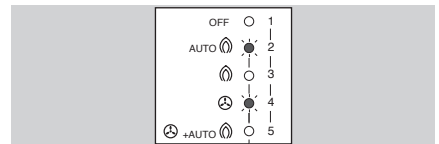

- ! The flame has gone out during operation. If a restart has been programmed, an automatic restart is carried out provided that the burner has been in operation for at least 2 s beforehand.
- Poor flame signal due to incorrect burner adjustment. Readjust gas pressure p_G , see page 6 (Adjusting the heater).
- Poor flame signal due to dirty or badly connected ionization electrode. Clean the ionization electrode and check for correct distance, see page 12 (Maintenance).
- Check the cable connection for damage or moisture. The plug must be fitted correctly.
- Check the yellow and green burner ground cable for corrosion and to ensure it is firmly connected.

? LEDs 1 and 4 flash.*

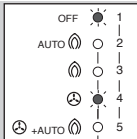

! A signal is applied for longer than 10 s to the remote reset input (terminals 31 and 32) (permanent remote reset).

- Remote reset must only be used to reset the device.

? LEDs 1 and 3 flash.

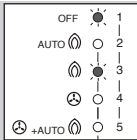

! The flame has not gone out within 5 s of the burner being switched off. The gas valve does not close correctly.

- Shut off the gas supply to the device. Check the burner and gas valves for correct function, see page 14 (Checking the safety functions and burner operation).

? LEDs 1 and 2 flash.*

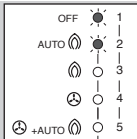

! The power supply has suffered a fault.

- Ensure there is sufficient mains voltage, see page 17 (Technical data).

? LEDs 3, 4 and 5 flash.

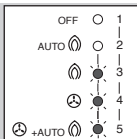

! While a fault was pending, more than 5 attempts were made within 15 minutes to reset the device using the remote reset input (terminals 31 and 32).

- Reset is only possible using the reset button on the BCU.

Maintenance

! CAUTION

To ensure that no damage occurs during operation and maintenance, please observe the following instructions. Otherwise, injuries or damage to the device may occur and/or the function of the device may be impaired. The supplier/manufacturer cannot accept liability for damage resulting thereof.

- Have the heater cleaned at least once a year by qualified maintenance personnel.
- Have the safety functions checked at least once a year by qualified maintenance personnel, see page 14 (Checking the safety functions and burner operation).
- Sharp-edged metal sheets. Always wear protective gloves.
- After cleaning or repair work, check that the components on and in the heater are in good condition. The device may only be restarted if all safety devices have been installed and the safety functions have been checked, see page 14 (Checking the safety functions and burner operation).

1 Switch off the burner control unit BCU.

2 Disconnect the system from the electrical power supply. The mains plug may only be pulled out once the device has been switched off and post-cooling is complete.

3 Shut off the gas supply.

- ▷ To facilitate cleaning of the components inside the housing, the maintenance cover on the casing can be opened.

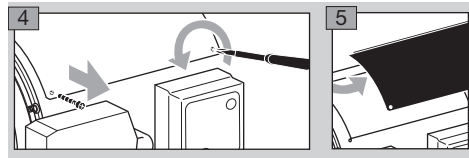

I = Ionization electrode

Z = Ignition electrode

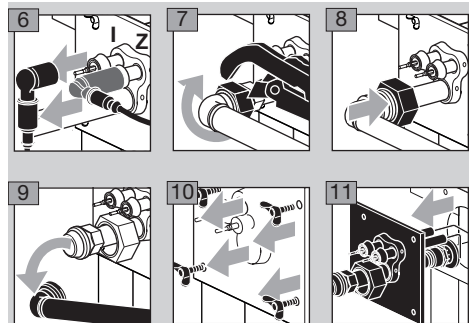

Checking the safety functions and burner operation

⚠ WARNING

If these checks are not carried out, the gas valves might remain open allowing non-combusted gas to escape. Risk of explosion!

Safety functions

- 1** Switch off the heater during operation. Press ON/OFF .
 - ▷ The flame goes out < 1 s.
 - ▷ The fan cools the heater down until it reaches switch-off temperature.
- 2** Remove the valve plug on the combination control during operation.
 - ▷ The gas valves close < 1 s.
 - ▷ The flame goes out.
 - ▷ The burner control unit BCU displays the fault message "The flame has gone out during operation". LEDs 2 and 4 flash.
 - ▷ If a restart has been programmed, the burner control unit will initially attempt to restart and will then perform a fault lock-out. LED 4 flashes and displays the fault message "No flame has been detected during the safety time".
- 3** Shut off the inlet pressure during operation.
 - ▷ The pressure switch in the combination control switches because the supply pressure is too low.
 - ▷ The burner control unit performs a safety shut-down: the gas valves are disconnected from the electrical power supply.
 - ▷ The flame goes out.
 - ▷ The burner control unit BCU displays the fault message "Supply pressure too low". LED 1 flashes.
 - ▷ If the burner control unit responds in a different way to that described, a fault has occurred, see page 9 (Assistance in the event of malfunction).

! CAUTION

The fault must be remedied before the system may be operated.

Checking burner operation

- 1** Switch on the BCU.
- 2** Select the Heating  operating mode.
- 3** Allow the burner to burn for 15 minutes.
- 4** During this time, monitor the flame pattern.
 - ▷ The flame must be blue.
 - ▷ No dirt particles must come out of the heater.

Accessories

Room thermostat

Use a room thermostat with a hysteresis of $\pm 1^\circ\text{C}$, 230 V, Type TH 215.

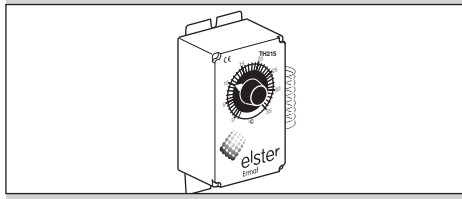

Order No.: N50260145

Pressure reducer

Pressure reducer for LPG.

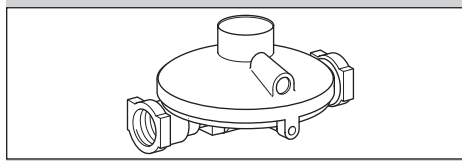

RECA 1.5 bar to 50 mbar, 2 x 1/2" internal thread connection, 10 kg/h, Order No.: N52600023.

Manual valve

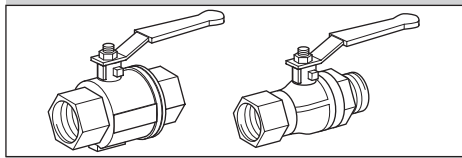

2 x 1/2" internal thread connection,
Order No.: N50260019.

1/2" internal and external thread connection,
Order No.: N50260027.

Connection kit for natural gas

Manual valve and gas hose to connect the gas combination control CG to the gas supply.

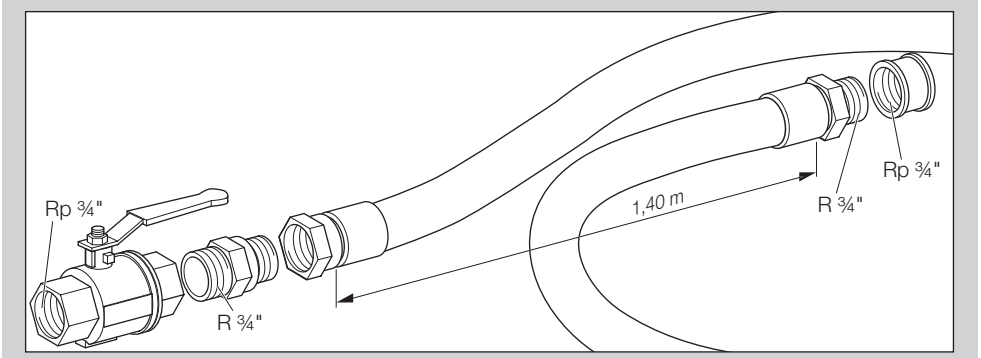

Connection kit: Rp 3/4" threaded connection, total length = 1.50 m, Order No.: N52600072

Connection kit for propane

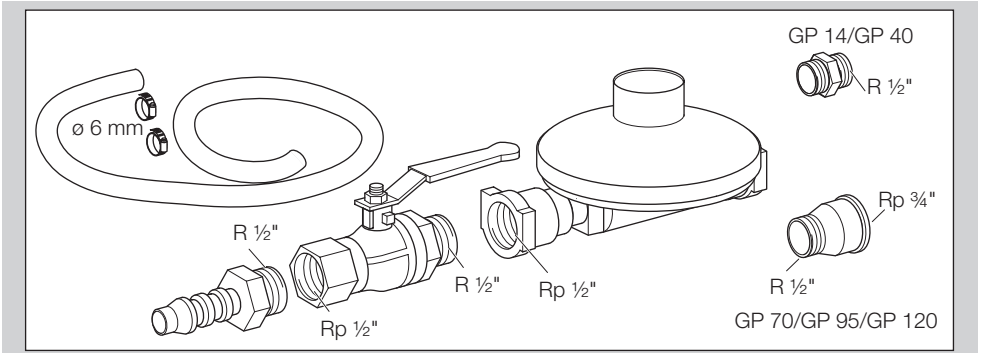

Pressure reducer, manual valve, hose (length = 2 m), 2 hose clamps, R 1/2" double nipple for GP 14/GP 40, R 1/2"-Rp 3/4" reducing fitting for GP 70-GP 120, to connect the gas combination control CG to the gas supply, Order No.: N52600025

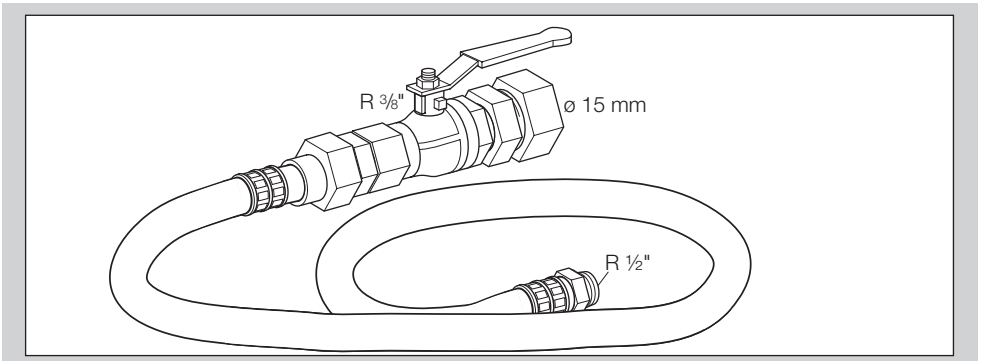

Manual valve and hose (DVGW certified, length = 2 m) to connect the gas combination control CG to the gas supply, Order No.: N52990209

Spare parts

- ▷ When ordering spare parts, please quote the order number along with the designation and item no. of the spare part as well as the heater serial number.
- ▷ When ordering spare parts which are not listed here below, please quote the edition of these operating instructions and the heater serial number.
- ▷ Use original spare parts only to ensure the replacement complies with the requirements stipulated by the manufacturer.

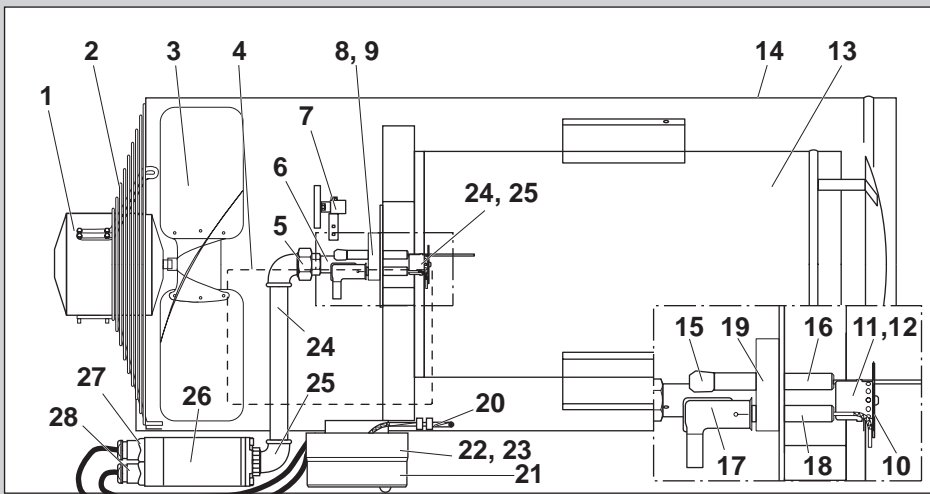

Item	Order No.	Designation
1	N50390100	Elnor fan motor for GP 95, BX 335 E55 AR 220V GP95 BCU, 300 W
2	N50390055	Safety grille for GP 95 fan
3	N52600032	Impeller wheel 18", 26°, for GP 95 and P 60
4	N50390034	Cover for maintenance opening GP 95/GP 120
5	N50390052	90° elbow, galvanized, Rp ¾"
6	N50260173	Pipe 178 mm, galvanized, R ¾"
7	N50260144	Vane switch, complete, universal for all devices, incl. 2-core cable
8	N50390090	Natural gas burner for GP 95, complete
9	N50390091	LPG burner for GP 95, complete
10	N50260167	Burner baffle plate for GP 95/GP 120/RGA, Ø 48 mm
11	N50390075	Natural gas nozzle for GP 95, 12 x Ø 2.7 mm, stainless steel
12	N50390076	LPG nozzle for GP 95, 12 x Ø 1.7 mm, stainless steel
13	N50390053	Burner chamber for GP 95
14	N50390050	GP 95 housing, stainless steel
15	N50500080	Ionization cable kit for GP series, incl. plug and seal
16	N50390006	Ionization electrode for GP 95/GP 120
17	N50260213	Ignition cable kit for GP 40–GP 120, complete with plug and cap
18	N50390005	Ignition electrode for GP 95/GP 120
19	N52600008	Electrode holder for GP 95/GP 120
20	N50260097	Temperature sensor for STM/STL, 6 x 45, L = 290 mm, TSK 1056 NTC (5 kΩ/25°C)
21	N50260101	BCU 300 upper housing section, incl. electronics, Kromschröder THP-GW 84636001
22	N50260102	BCU 300 lower housing section, incl. ignition transformer
23	N50260109	Ignition transformer for gas, Eichhof E4718/55, 1-pin
24	N50260172	Pipe 270 mm, galvanized, R ¾"
25	N50260171	90° male/female elbow, galvanized, R ¾"/Rp ¾"
26	N50260123	Gas combination control CG 220 for GP 70–GP 120, Kromschröder CG 220R01-DT2WF1Z
27	N50260119	Plug for pressure switch, grey
28	N50260118	Plug for valves, black
29	N50260147	Protective cap for BCU, PVC, black, with viewing window
30	N50260148	Protective cap for gas combination control CG 220, PVC, black

Technical data

Inlet pressure p_U :
natural gas: 20–25 mbar,
propane: 35–50 mbar.
Setting of the gas pressure switch p_W :
natural gas: 10 mbar,
propane: 30 mbar.
Gas connection: R ¾" external thread.
Material:
casing: stainless steel 430,
burner chamber: stainless steel 430,
BCU: PPE.
Ambient temperature:
-10 to +60°C. No condensation permitted.
Cycle lock: 15 s.
Capacity: 95 kW.
Gas consumption:
natural gas L: $\pm 9.2 \text{ m}^3/\text{h}$,
natural gas H: $\pm 7.8 \text{ m}^3/\text{h}$,
propane: $\pm 6.8 \text{ kg}/\text{h}$.
Connection rating:
230 V AC, -15/+10%, 50/60 Hz, 500 W.
Power consumption: I_A/I_N : $\pm 5 \text{ A}/2.2 \text{ A}$.
Air circulation:
Controlled air flow: $\pm 5000 \text{ m}^3/\text{h}$,
Heating: $\pm 6500 \text{ m}^3/\text{h}$.
Jet length: 40 m.
Housing:
length: 1150 mm,
width (total): 590 mm,
height/diameter: 484 mm,
weight: 37 kg.

Declaration of conformity



We, the manufacturer, hereby declare that the product GP complies with the requirements of the listed Directives and Standards.

Directives:

- 2009/142/EC
- 2004/108/EC
- 2006/42/EC
- 2006/95/EC

Standards:

- DIN 3362, EN 298
- EN 60730
- EN 1643, EN 525:2009

The relevant product corresponds to the type tested by the notified body 0085.

The production is subject to the surveillance procedure pursuant to Directive 2009/142/EC according to annex II paragraph 3.

Elster-Instromet B.V.

Scan of the Declaration of conformity (D, GB) – see www.docuthek.com

Goods return form

Name of the operator

P.O. Box/Street

Postcode and town/city

Tel.

E-mail

Returned by (Mr./Ms.)

Date

Number of returns

Heater serial number

Power supply [V/Hz]

Inlet pressure p_u [bar]

Reasons for return

Description of fault

Desired action

Credit note

Replacement

Repair

Remarks

Date and signature

Please send returns back to your supplier.

Contact

If you have any technical questions, please contact your local branch office/agent. The addresses are available on the Internet or from Elster-Instromet B.V.

Munstermanstraat 6
7064 KA Silvolde

T +31 315 338-911
F +31 315 338-679

We reserve the right to make technical modifications in the interests of progress.

elster
Kromschroder

Elster-Instromet B.V.
Sales Office

Postfach 2809, 49018 Osnabrück
Strohteweg 1, 49504 Lotte (Büren)
Germany

T +49 541 1214 702

F +49 541 1214 506

orders.ermaf@elster.com, www.ermaf.com