

03251553

ermaf //



 → www.docuthek.com

Operating instructions Heater RGA 100 ACU



Contents

Heater RGA 100 ACU	1
Contents	1
Safety	1
Checking the usage	2
Installation	2
Tightness test	4
Wiring	4
Commissioning	8
Adjusting the heater	10
Cleaning	12
Assistance in the event of malfunction . . .	14
Maintenance	20
Checking the safety functions and burner operation	21
Accessories	21
Spare parts	25
Technical data	26
Certification	27
Logistics	27
Goods return form	28
Contact	28

Safety

Please read and keep in a safe place



Please read through these instructions carefully before installing or operating. Following the installation, pass the instructions on to the operator. This unit must be installed and commissioned in accordance with the regulations and standards in force. These instructions can also be found at www.docuthek.com.

Explanation of symbols

 **1, 2, 3...** = Action
 > = Instruction

Liability

We will not be held liable for damage resulting from non-observance of the instructions and non-compliant use.

Safety instructions

Information that is relevant for safety is indicated in the instructions as follows:

DANGER

Indicates potentially fatal situations.

WARNING

Indicates possible danger to life and limb.

! CAUTION

Indicates possible material damage.

All interventions may only be carried out by qualified gas technicians. Electrical interventions may only be carried out by qualified electricians.

Persons under the age of 18 as well as persons with reduced physical, sensory or mental capabilities or lack of experience and knowledge are not allowed to use, clean or service this device. Staying near the device or its use is prohibited, even if said persons are supervised or have been instructed on the safe use of the devices and are aware of the resulting dangers.

Conversion, spare parts

All technical changes are prohibited. Only use OEM spare parts.

Checking the usage

RGA 100 ACU

Heater with indirect combustion for animal sheds and horticultural greenhouses. Depending on the type and setting, the heater can be operated with natural gas or LPG (propane/butane).

This function is only guaranteed when used within the specified limits – see page 26 (Technical data). Any other use is considered as non-compliant.

Type code

Code	Description
RGA 100	Heater

Part designations

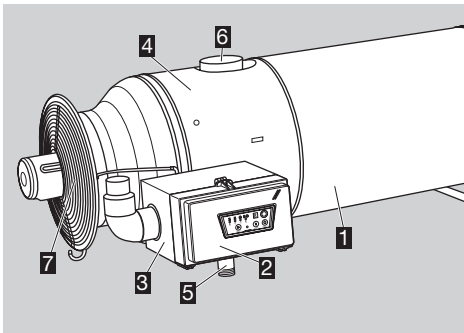

- 1 Stainless steel housing RGA 100 ACU
- 2 Housing cover with burner control unit ACU (service form in housing cover)
- 3 Operating box
- 4 Service flap
- 5 Connection for gas combination control
- 6 Connection for chimney with condensate vessel (not included in the delivery)
- 7 Main fan

Type label

Air circulation, electrical connection rating, rated heat input, gas type, category, supply pressure, burner pressure, enclosure: see type label.

- Before installation, check whether the device is suitable for the regional gas type and the specified limits, see type code and page 26 (Technical data).

Installation

⚠ DANGER

Danger of death! Gases are generated during the storage of slurry which remain partly dissolved in the liquid. If the slurry is strongly agitated during mixing and purging, poisonous, explosive gases such as hydrogen sulphide and methane are released. If an ignition source is present, the released gas can explode.

To avoid damage during operation, please observe the following:

- Switch off the heater before mixing and purging the slurry.
- Close the slide valves when storing slurry outside.
- The fan for the air supply must not be part of a closed pipe system.
- Respect the safety distance of the heater to inflammable materials, see “Installation position”.
- Consult your fire insurance provider and/or local fire protection engineer to assess the foreseeable, general risk of fire.
- For cleaning, care and maintenance, note the applicable national regulations and directives.
- No condensation permitted. Comply with ambient temperature, see page 26 (Technical data).

Installation position

- ▷ Installation in the horizontal position.
- ▷ Note the safety distance to walls and inflammable materials.

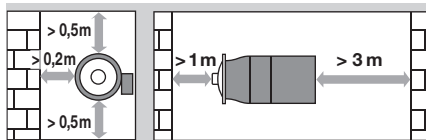

- ▷ Ensure sufficient free space around the device. There must be no obstructions in front of the inlet and outlet side of the heater.
- ▷ The distance between the heaters should be greater than 30 m.
- ▷ To avoid overheating, do not cover the main fan.

Chimney

! CAUTION

The RGA 100 is only deemed CE tested and approved when used with the coaxial chimney described in "Accessories".

- ▷ Do not exceed the maximum length (5 m) of the chimney.
- ▷ The design of the chimney depends on the premises and the roof construction.
- ▷ Various chimney elements for individual applications can be supplied, see page 21 (Accessories).
- ▷ The wall mounting bracket cannot be installed in the correct position until the chimney has been selected.

Siphon connection

⚠ DANGER

Risk of poisoning!

- If the RGA 100 is operated without a siphon or with an empty siphon, toxic flue gases may escape. If the RGA 100 is operated without a siphon, the opening must remain unobstructed.
- ▷ A siphon must be connected before initial commissioning. This prevents the escape of toxic flue gases and will also collect any condensate contained in the flue gas.
- ▷ The siphon is not included in the delivery and must be ordered separately for the nominal diameter of 17.5 mm.
- ▷ Fill the siphon with water before initial commissioning.
- ▷ If large volumes of condensate are discharged, we recommend that an additional drain pipe is connected to the siphon.

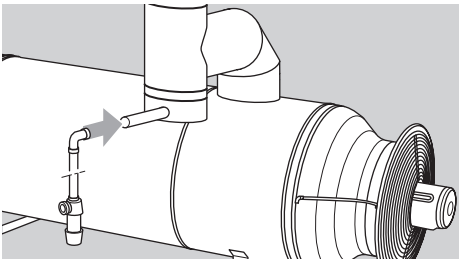

- ▷ If the heater has not been used for a lengthy period, the siphon must be checked, cleaned and filled with water before commissioning.
- Unscrew the siphon, remove it and fill it until water flows out of the side drain.
- Secure the siphon again and ensure that the seal is correctly positioned.

Connecting the gas supply

- ▷ The RGA 100 is set to the correct gas type as specified in the purchase order.
- ▷ If you wish to use a different gas type, see page 3 (Changing the gas type).
- 1 Disconnect the system from the electrical power supply.
- 2 Shut off the gas supply.
- 3 Remove the sealing plug from the gas inlet on the combination control on the underside of the RGA 100.
- 4 Connect the gas pipe with an Rp 3/4" threaded connection or gas hose with an Rp 3/4" connector, see page 21 (Accessories).
- ▷ Use approved sealing material only.

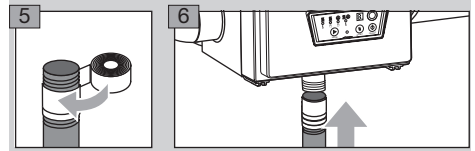

Changing the gas type

- ▷ If you wish to use a gas type other than the one specified in the purchase order, the RGA 100 must be adjusted to the new gas type, see page 10 (Adjusting the heater).
- ▷ Then seal the gas pressure setting.
- ▷ Note the new gas type on the type label with a waterproof pen.

Tightness test

- ▷ The heater may only be disconnected from the electrical power supply once the device has been switched off.
- 1** Disconnect the system from the electrical power supply.
- ▷ The valves are closed when de-energized.
- 2** Open the housing cover of the operating box.
- 3** Open the pressure test point for p_u **1** on the gas combination control.
- 4** Connect a pressure gauge to **1**.

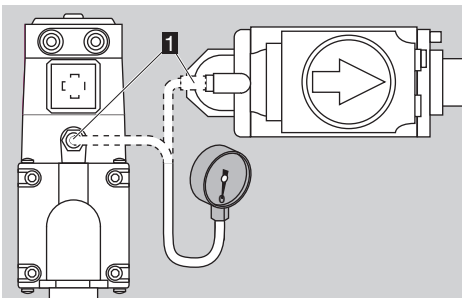

- 5** Switch on the power supply.
- 6** Release the gas supply.
- 7** Check the maximum inlet pressure p_u .
- ▷ The maximum inlet pressure p_u must not be exceeded.
- 8** Close the manual valve.
- 9** Monitor inlet pressure p_u on the pressure gauge.
- ▷ The pressure must not drop.

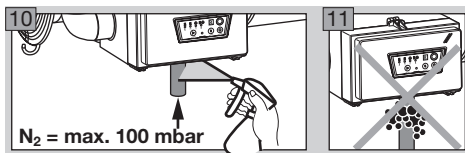

- 12** Having successfully completed the tightness test, remove the pressure gauge and close the pressure test point for p_u **1**.

Wiring

! CAUTION

Danger of electric shocks!

- Before working on possible live components, ensure the unit is disconnected from the power supply.
- The RGA 100 must have an external 16 A fuse.
- It must be possible to isolate the system from the power supply. The RGA 100 must be equipped with a mains cable or a plug featuring a contact gap according to the specifications for Over-voltage category III for full isolation at each pin. If this is not the case, the permanently wired electrical installation must include an isolating switch of this type pursuant to the local installation regulations.

- ▷ The heater may only be disconnected from the electrical power supply once the device has been switched off.

- 1** Disconnect the system from the electrical power supply.
- 2** Shut off the gas supply.
- 3** Open the housing cover of the operating box.

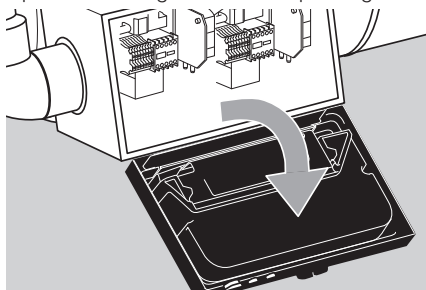

- ▷ External electrical interference must be avoided.
- ▷ The selection of cables and mains plug must comply with local/national regulations.

- 4** Open the cover of the burner control unit.

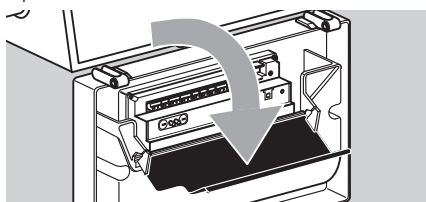

Connection diagram

- ▷ The burner control unit is fitted with coded connectors to prevent them being mixed up.

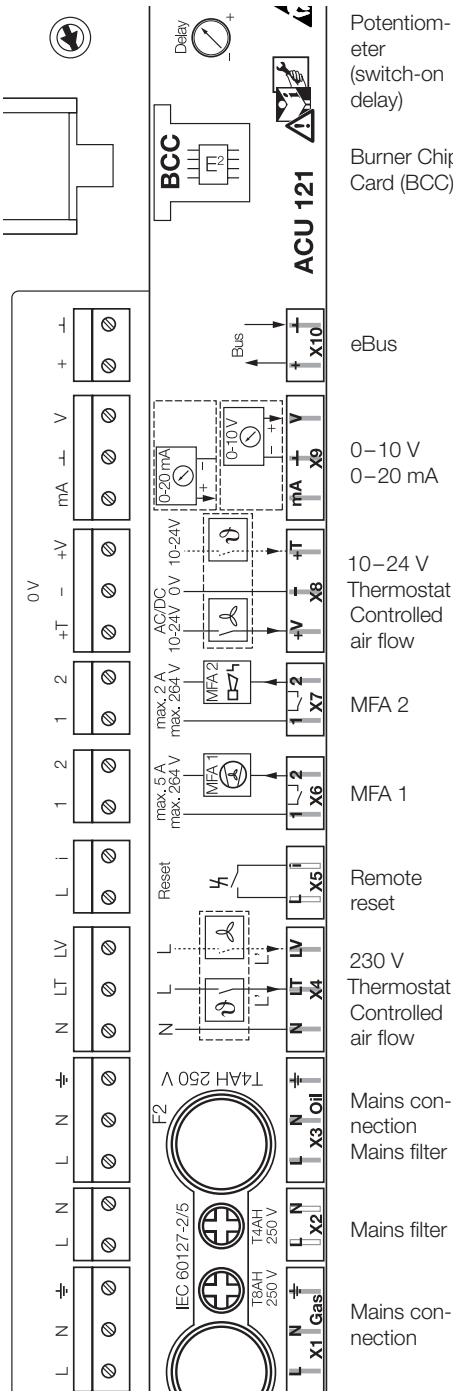

Connecting the room thermostat

! CAUTION

To avoid damage to the heater RGA 100, please observe the following:

- Provide post-cooling for the RGA 100. The RGA 100 requires a continuous supply of 230 V AC (1/N AC), 50 Hz.
- In case of a power failure, an emergency power supply unit should automatically take over the power supply. Emergency power supply units with a cardan shaft drive for tractor attachment are also suitable.
- ▷ Use a room thermostat with a hysteresis of $\pm 1^\circ\text{C}$. It switches on if the room temperature is 1°C less than the set temperature and switches off again once the room temperature is 1°C more than the set temperature.
- ▷ The floating connectors X4 (230 V) or X8 (24 V) are used to connect the room thermostat.
- ▷ If the room thermostat is connected to the mains supply of other connectors (connector X1 or X3), the heater RGA 100 will be damaged.

Connecting a single heater to a room thermostat

5 Connect a room thermostat for 230 V AC.

- ▷ Method 1: power supply via the heater.

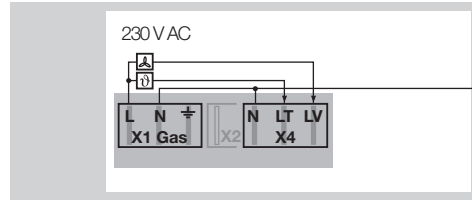

- ▷ Method 2: power supply via the environmental control computer.

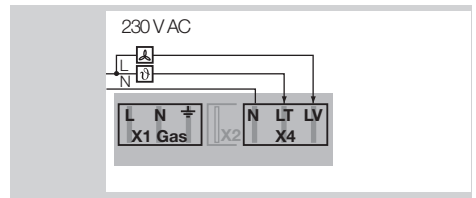

5 Connect a room thermostat for 24 V DC/AC to connector X8.

- ▷ The 24 V power supply must always be from an external source.

10-24 V AC/DC

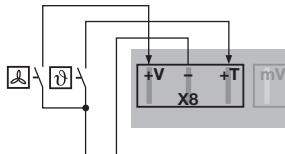

Connecting multiple heaters to a room thermostat or an environmental control computer

5 Connect a room thermostat for 230 V AC.

- ▷ Method 1: power supply via the heater.

230 V AC

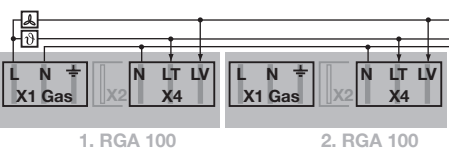

- ▷ Only one bridge may be connected to a single heater between connectors X1 and X4. "N" may be connected to all successive heaters between connectors X4 only.

230 V AC

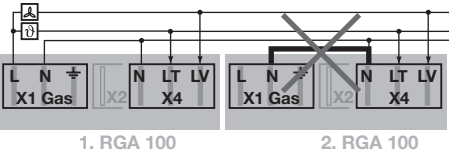

- ▷ Method 2: power supply via the environmental control computer.

230 V AC

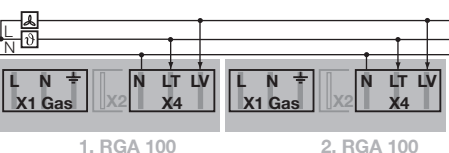

5 Connect a room thermostat for 24 V DC/AC to connector X8.

- ▷ The 24 V power supply must be from an external source.

10-24 V AC/DC

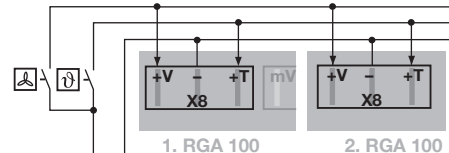

Remote reset

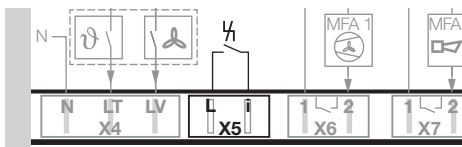

- ▷ An external remote reset may be connected to connector X5.

Multi-functional outputs

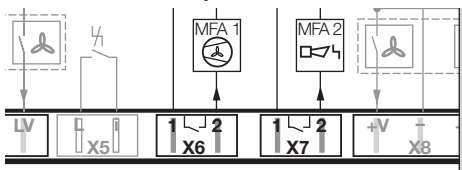

- ▷ Floating multi-functional outputs can be parameterized using connectors X6 and X7. There are two methods of completing this parameterization: The PC software for burner control units BCSoft can be used via the optical interface on the burner control unit, see page 21 (Accessories). The "Setting mode" menu can be opened using the MODE selection button (heater OFF) and used for parameterizing the outputs, see page 9 (Setting mode).

- ▷ **MFA 1, external fan** (max. 5 A)

For improved air circulation in the room, an additional fan can be connected. The external fan can be actuated with an adjustable delay (BCSoft) for switching it on and off. The exact time relates to the operation of the main fan.

- ▷ Possible parameterization options:
 - Inactive: the external fan is not actuated.
 - Main fan active: the external fan is actuated at the same time as the main fan.
 - Main fan inactive: the external fan is actuated when the main fan of the RGA 100 switches off.
 - Modulation enable: the external fan is not actuated until the RGA 100 starts modulating operation.

- ▷ **MFA 2, status signal** (max. 2 A)
Possible parameterization options:
 - Fault NO (default setting):
For example, the input for a horn can be set to NO.
 - Fault NC:
The input on an environmental control computer can be set to NC (e.g. to indicate a cable discontinuity).
 - Operation
 - Standby

Selecting the burner capacity

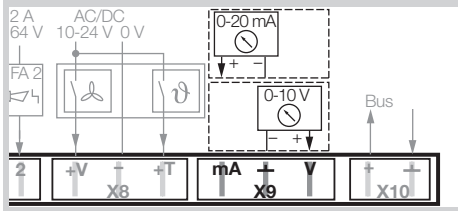

- ▷ Connector X9 is not wired at the factory. In other words, the burner heats at its full capacity.
- ▷ A capacity range from 60 to 100% can be selected using a voltage or current signal. A signal sensor is connected to connector X9 for this purpose:
 - 0 mA/0 V = maximum capacity,
 - 20 mA/10 V = minimum capacity.

Burner Chip Card (BCC)

- ▷ All the data relevant to the device are saved on the BCC and the internal device memory (EEProm). In addition, the parameters are saved on the BCC.

! CAUTION

Danger of electric shocks!

- Before working on possible live components, ensure the unit is disconnected from the power supply.
- If the BCC is removed from the burner control unit, the heater RGA 100 will be non-functional.
- ▷ In the event of faults which cannot be rectified by authorized trained personnel, contact the supplier.
- ▷ The BCC can be removed from the burner control unit and submitted for diagnostic purposes by agreement with the supplier.

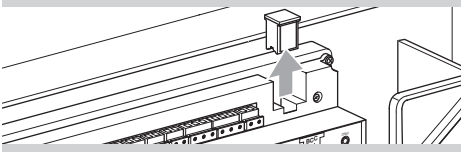

- ▷ If no other fault is active, the RGA 100 can be readied for use again by inserting a new BCC. The BCC must be compatible with the RGA 100 and the gas type used.

Setting the switch-on delay

- ▷ If multiple heaters switch on at the same time, there can be a gas and/or power shortage on individual devices. To avoid this happening, adjust the switch-on delay using the potentiometer on the burner control unit.
- ▷ The potentiometer is set to 0 s at the factory.

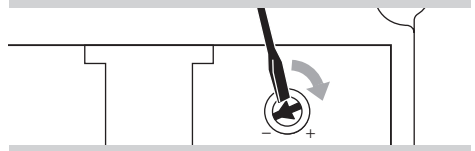

- ▷ If necessary, a switch-on delay of 5 to 10 s can be set between the devices.
- 6** After completing the wiring, close the cover and the housing cover on the burner control unit again.
- 7** Switch on the power supply.
- ▷ A circulating dash will be displayed when the voltage supply is switched on to indicate that the switch-on delay is running.



- 8** Release the gas supply.
- 9** Commission the heater.

Commissioning

! CAUTION

To avoid damage to the heater RGA 100, please observe the following:

- Ensure that the heater, gas pipes, mains voltage supply and room thermostat have been installed by authorized trained personnel according to the regulations.
- The Burner Chip Card (BCC) must be compatible with the heater, the version, the gas type used and the factory default parameters.
- The heater may only be operated with the gas type specified on the type label.
- If the device needs to be converted to be operated with a different gas type:
 1. Use the correct nozzle, see page 25 (Spare parts).
 2. Set the appropriate pressure on the burner, see table on page 11 (Natural gas, LPG).

Operation

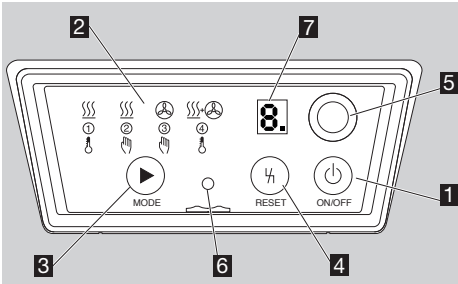

- 1 ON/OFF
- 2 Operating modes
- 3 MODE selection button
- 4 RESET
- 5 Status indicator
- 6 Optical interface
- 7 7-segment display

Description

- 1 ON/OFF : to switch the heater on and off.
- 2 Operating modes:

Operating mode	Explanation
 ①	The burner control unit waits for the signals for controlled air flow or heating (automatic)
 ② 	Continuous heating (manual)
 ③ 	Controlled air flow in continuous operation (manual)
 ④ 	Controlled air flow in continuous operation and heating when a thermostat signal is applied (automatic)

- 3 MODE selection button (heater switched on):
By pressing the MODE selection button, it is possible to switch between the different operating modes.

By pressing and holding the MODE selection button in operating mode ② Heating, the current capacity setting is displayed and can be selected, see page 11 (Display and selection of the capacity setting).

MODE selection button (heater switched off):

By pressing and holding the MODE selection button, you can go to Setting mode, see page 9 (Setting mode). The multi-functional outputs can be assigned and the eBus address specified in this mode.

- 4 RESET: internal reset button

- 5 Status indicator (light):

red: fault

yellow: standby/ready for operation

green: RGA 100 in operation

- 6 Optical interface:

The PC software BCSoft can be used with the PC opto-adapter via this interface, see page 21 (Accessories).

- 7 7-segment display:

Error code

Flame signal

Number of operating cycles

can be displayed. The decimal point indicates that another figure follows.

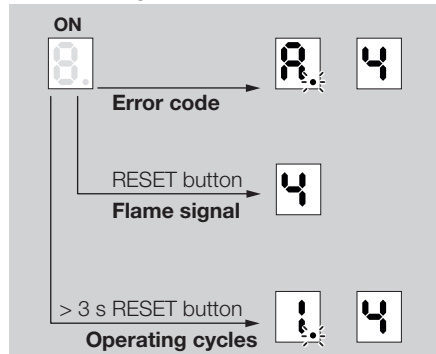

Error code: an error is displayed immediately in the form of an alternating letter and number indicating a warning or fault, see page 14 (Assistance in the event of malfunction).

Flame signal: pressing the RESET button displays the flame signal, see page 12 (Flame signal).

Operating cycles: pressing and holding the RESET button for more than 3 s displays the number of operating cycles in changing displays, see page 20 (Maintenance).

- ▷ Press the RESET button to exit the display of the flame signal or operating cycles.

Switching on

- Press ON/OFF .
 - The LED for the last selected operating mode will flash. A different operating mode can be selected within 2 s. If you retain the selection, the flashing light will change to permanently lit after 2 s.
- ▷ The heater will start once the thermostat signal has been applied and the set switch-on delay elapsed, see page 7 (Setting the switch-on delay).
- ▷ The burner starts after approx. 20 s and operates in the last selected operating mode.

Switching off

- Press ON/OFF . The burner control unit display and the burner will switch off immediately. Mains voltage is still supplied however. The display indicates “-”.
- ▷ The main fan cools the heater down until it reaches switch-off temperature.

! CAUTION

- Do not disconnect the heater from the electrical power supply until the cooling process has been completed.
- ▷ The display “-” will go out.

Setting mode

- ▷ You can go to Setting mode by pressing and holding the MODE selection button when the heater is switched off.
- Switch off the heater .
- ▷ Mode E: eBus addresses can be saved.
- Mode A/F: multi-functional outputs can be parameterized.

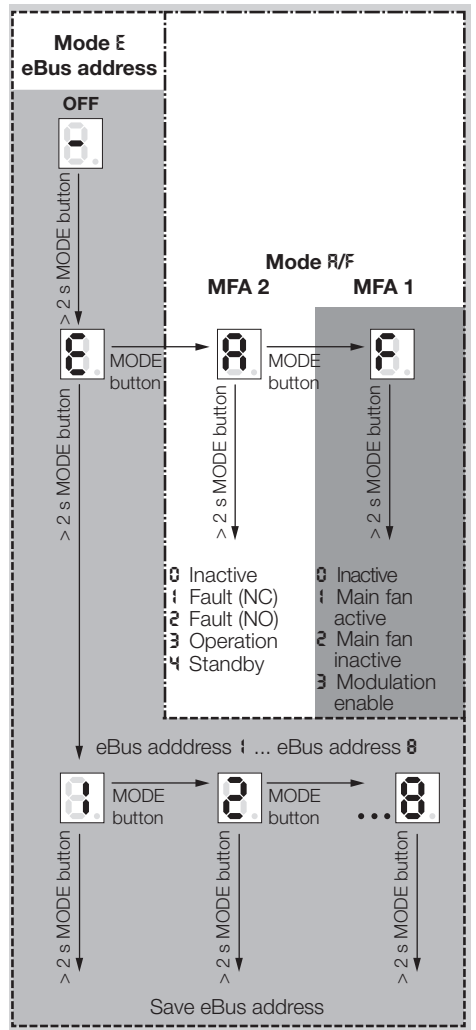

- ▷ Press the RESET button to return to the previous menu.
- ▷ After a timeout of 20 s, the display will automatically return to the initial mode. The display indicates “-”.

Adjusting the heater

- 1 Mount the flue gas outlet in accordance with the local regulations.
- 2 Make sure the outside air supply **5** between the operating box and the chimney is connected.

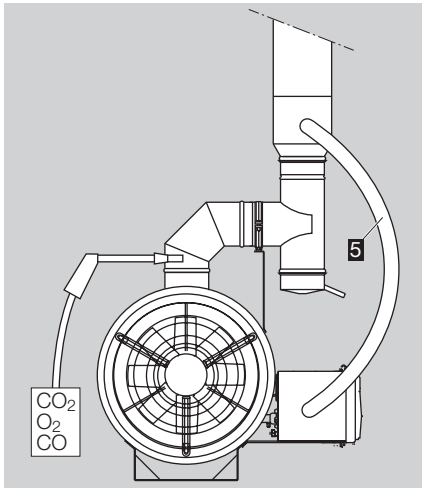

- ▷ The heater is set to the gas type specified in the purchase order.

- 3 Check whether the values in the table for gas type and adjusting range correspond to local conditions.

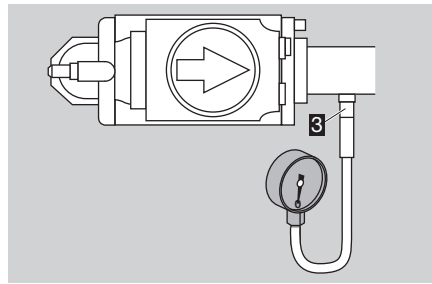

	Heating value H_s [MJ/m ³]	
	Minimum	Maximum
Natural gas L G 25	30.58	35.05
Natural gas H G 20	34.04	40.75
LPG G 30	90.76	125.75

- ▷ The fine adjustment on the gas combination control is made on the basis of the flue gas measurements on the chimney.
- ▷ The following are required for setting:
 - 2.5 mm Allen key,
 - Pressure gauge with display range 0 to 50 mbar,
 - Flue gas analyzer. The flue gas analyzer must be able to measure λ (lambda), O₂, CO and CO₂. The sensor should be suitable for temperatures of up to 300°C.
- ▷ The inlet pressure p_u must comply with the technical data, see page 26 (Technical data). Important! Always check the inlet pressure when the RGA 100 is in operation.
- ▷ The burner pressure p_G can be measured using a test point **3** between the combination control and the housing wall.

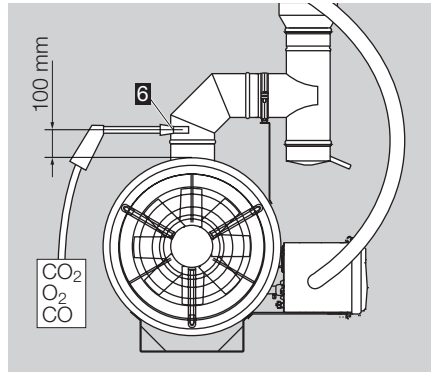

- 4 Open the pressure test point for p_G **3**.
 - ▷ Do not use force!
- 5 Connect a pressure gauge to **3**.
- 6 Disconnect the system from the electrical power supply.
 - ▷ The heater may only be disconnected from the electrical power supply once the device has been switched off and post-cooling is complete.
- 7 Shut off the gas supply.



- 8 Drill a hole in the flue gas pipe 100 mm above the stainless steel housing of the RGA 100 to insert the flue gas analyzer sensor.
- 9 Insert the sensor into the hole **6** and position in the centre of the flue gas pipe.
- 10 Ensure that there is no air in the gas system.
- 11 Switch on the power supply.
- 12 Release the gas supply.
- 13 Measure the CO, λ and O₂ values simultaneously and observe them.
- 14 Switch on the burner control unit. Press ON/OFF  until an LED lights up.
 - ▷ The burner control unit switches on in the last operating mode selected.
- 15 Select operating mode **2**  Heating.

Display and selection of the capacity setting

! CAUTION

Only for testing in modulating operation. The RGA 100 is optimally adjusted and sealed for the low-fire rate. Afterwards, it is essential to switch back to maximum capacity operation.

- ▷ This display is only possible when the heater is switched on.
- ▷ The current capacity setting can be displayed by pressing and holding the MODE selection button in operating mode ② Heating.



- ▷ If the top dash is lit, the heater is operating at maximum capacity.
- ▷ If the bottom dash is lit, the heater is operating at minimum capacity.
- ▷ If the dash flashes, the heater has not yet reached the capacity setting.
- ▷ When the capacity setting has been reached, the dash will be lit for 15 s. During this time, you can switch between minimum and maximum capacity setting by pressing and holding the MODE selection button again.
- ▷ The display will go out after 15 s. The display can be reactivated by pressing and holding the MODE selection button again.
- ▷ The display can be cancelled at any time by pressing the RESET button.

Setting the high-fire rate

! CAUTION

To avoid damage to the heater RGA 100, please observe the following:

- CO₂ adjustment may only be made using the adjusting screw **2**.
- The zero point setting **4** is sealed and should not be changed.

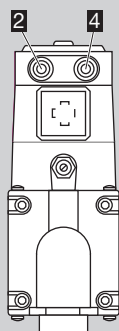

- ▷ The heater must be operated at maximum capacity.
- ▷ Having initiated the ignition process, the burner should start within 3 s.
- ▷ If the burner does not ignite after several attempts, the inlet pressure is too low or the burner pressure is set too low.
- ▷ Turn the adjusting screw **2** half a turn in the + direction using the Allen key.

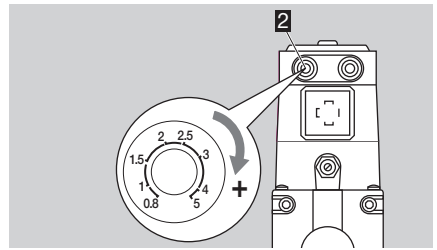

- ▷ If the burner still does not ignite, turn the adjusting screw further in the + direction.
- ▷ The burner pressure p_G can be read during the start-up process. The burner pressure should not exceed the values in the table.
- ▷ If the burner starts successfully, you can observe the flue gas analyzer to see how the λ and O₂ values change.
- ▷ Check the limit values for λ and O₂.
- 16** Monitor the CO value.
- ▷ During a normal start-up, the CO value will rise briefly and then fall quickly again.

! CAUTION

To avoid damage to the heater and flue gas analyzer, please observe the following:

- The CO value may rise briefly to 500 ppm immediately after ignition. If the CO value does not drop after a short time, immediately reduce the CO₂ value by turning the adjusting screw **2** anti-clockwise. Take the flue gas analyzer sensor out of the test point immediately.

- ▷ The RGA is suitable for the following gas types:

Gas type	Natural gas, LPG	
	Heating value [MJ/m ³]	Wobbe index
Natural gas L G 25	32.49	41.53
Natural gas H G 20	37.78	50.71
LPG G 30	125.81	87.34

Gas type	G+ K gas*	
	Wobbe index min. [MJ/m ³]	Wobbe index max. [MJ/m ³]
G+ K gas	43.46	45.3

* see page 27 (The Netherlands)

- 17** Allow the heater to operate for 10 minutes.
- ▷ During a normal start-up, it may take a few seconds for the main fan to start the cooling process.

- 18** Read the burner pressure at the pressure test point for p_G and readjust if necessary. Measure the λ and O_2 values with a calibrated flue gas measuring instrument and adjust according to the values in the table:

Gas type	Inlet pressure p_U [mbar]		Burner pressure p_G [mbar] max.	Lambda λ		O ₂ [%]	
	min.	max.		min.	max.	min.	max.
Natural gas L G 25	25	100	15.5	1.2	1.35	3.5	5.4
Natural gas K gas (G+)	25	100	15.5	1.2	1.35	3.5	5.4
Natural gas H G 20	20	100	11.5	1.2	1.35	3.5	5.4
LPG butane G 30	29	100	18.7	1.2	1.35	3.5	5.4
LPG propane G 31	29	100	22.0	1.2	1.35	3.5	5.4

- ▷ If the burner pressure is \leq the value in the table and the minimum λ and O_2 values are not reached, reduce the burner pressure until the λ and O_2 values are between the min./max. limits.
- ▷ If the burner pressure is \leq the value in the table and the maximum λ and O_2 values are exceeded, increase the burner pressure by a maximum of 5%.
- ▷ If the measured values correspond to the details on the type label and in the table, the heater has been set correctly. Otherwise, continue with the measurement and fine adjustment until the heater is correctly set.
- ▷ Heater adjustment is now complete.

! CAUTION

To avoid damage to the heater RGA 100, please observe the following:

- The low-fire rate may only be set by authorized trained personnel by agreement with the manufacturer.
- ▷ A service form can be found inside the housing cover. All settings for the future use of the heater and any guarantee claims are to be kept up-to-date on this form.

Flame signal

- ▷ The flame signal can be displayed when the burner is operating.
- 1** Pressing the RESET button displays the flame signal.
- ▷ It is shown in coded form as a number from 0 to 9. This number must be multiplied by a factor of 2. The result of this multiplication is the level of the flame signal in μA . Example: the number 3 corresponds to a flame signal of 6 – 8 μA .

Display	Flame current [μA]	Display	Flame current [μA]
0	0–2	5	10–12
1	2–4	6	12–14
2	4–6	7	14–16
3	6–8	8	16–18
4	8–10	9	18...

- 2** Check the flame signal.
- ▷ The flame signal is displayed for 20 s.
- 3** Press the RESET button to exit the flame signal display.
- ▷ If the flame signal is $< 2 \mu A$, fault *F* (flame fault) *1* or *2* is displayed, see page 14 (Assistance in the event of malfunction).

Cleaning

! CAUTION

To ensure that no damage occurs during operation and cleaning, please observe the following instructions. Otherwise, injuries or damage to the device may occur and/or the function of the device may be impaired, and the manufacturer's warranty will be cancelled.

- Sharp-edged metal sheets. Always wear protective gloves.
- After cleaning, check that the components on and in the heater are in good condition. The device may only be restarted if all safety devices have been installed and the safety functions have been checked.
- Clean the heater once a year when used in horticulture and at regular intervals as well as after each fattening period when used in agriculture, as described below. Inadequate or irregular cleaning can cause the device to overheat and can thus lead to fire damage or damage to the device. For example, dirt particles can catch fire and can be blown out of the heater.
- ▷ The RGA 100 is made of high-quality stainless steel and is resistant to external influences such as dirt and moisture.
- ▷ It is designed so that it can be cleaned carefully both inside and outside with a high-pressure cleaner.
- ▷ The housing cover and cable glands on the burner control unit must be closed during the cleaning process.

- ▷ The electrical components are protected from moisture by additional water drip edges on the housing cover. Nevertheless, direct water influence on the edges of the housing cover should be avoided.
- ▷ A downward slope inside the device ensures that dirty water drains out.
- ▷ Never direct the high-pressure cleaner at the heater when it is set to water jet. Always use the spray setting.
- ▷ The distance between the nozzle and the surface to be cleaned must always be at least 50 cm. Too short a water jet from the high-pressure cleaner can cause serious damage to the device.

- 1** Switch off the burner control unit.
- 2** Disconnect the system from the electrical power supply.
- ▷ The heater may only be disconnected from the electrical power supply once the device has been switched off and post-cooling is complete.
- 3** Shut off the gas supply.
- 4** Check the cover on the burner control unit and the housing cover to ensure they are both tightly closed.

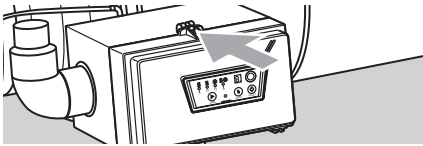

- ▷ The heat exchanger can be easily accessed via the service flap.
- 5** Clean the heat exchanger and burner by means of a water jet directed through the safety grille past the fan blades

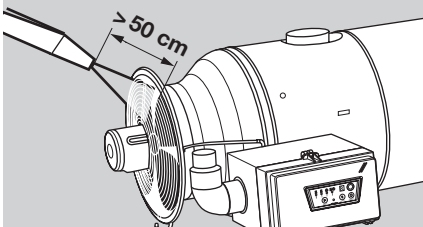

- ▷ If the RGA is heavily soiled, the safety grille can be removed together with the fan:

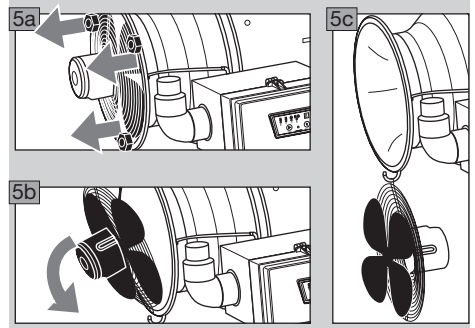

- 5d** Refit the safety grille and fan after cleaning: To do so, slightly tighten the nuts, check the fan blades for smooth operation and freedom of movement and then firmly tighten the nuts.
- ▷ The rubber seals between the electrodes and terminal boots may be displaced by the water jet.
- 6** After cleaning, check that all the parts on and in the heater are in the correct positions, for example whether the rubber seals between the electrodes and terminal boots are fitted correctly.
- 7** Chemical cleaning agents, disinfectants and/or pesticides contain corrosive substances which can even corrode stainless steel. Always rinse the devices with water after cleaning using such agents to remove any residue of these agents from the surface.
- 8** After cleaning, select operating mode ③ (Controlled air flow so that the interior of the device can dry properly).
- 9** After cleaning the heater, check it is functioning faultlessly in normal operation, see page 21 (Checking the safety functions and burner operation).
- 10** When operating with LPG, check and clean the breather orifice of the pressure reducer.

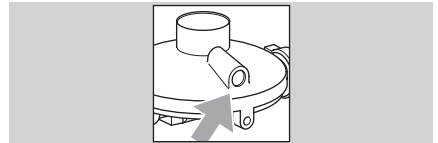

Assistance in the event of malfunction

⚠ WARNING

To avoid harm to persons and animals or damage to the heater, please observe the following:

- Electric shocks can be fatal! Before working on possible live components, ensure the unit is disconnected from the power supply.
 - Fault-clearance must only be undertaken by authorized trained personnel!
 - Repairs to components, e.g. the burner control unit or the combination control, may only be carried out by the manufacturer. Otherwise, the warranty will be cancelled. Unauthorized repairs or incorrect electrical connections, e.g. the connection of power to outputs, can cause gas valves to open and the burner control unit to become defective. In this case, fail-safe operation can no longer be guaranteed.
 - (Remote) resets may only be conducted by authorized trained personnel with continuous monitoring of the devices concerned.
- ▷ In the event of an installation fault, the burner control unit closes the gas valves and the status indicator light will be red at the latest after a restart has been unsuccessful.
- ▷ The 7-segment display will show an error code in the form of a letter with a decimal point and a number alternately indicating a warning. Together with the red status indicator light, this then constitutes a fault.
- ▷ Warnings and faults may be cleared only using the remedies described below.

Internal wiring

- ▷ To rectify a fault, it is sometimes necessary to check the internal wiring.

- 1** Open the housing cover of the burner control unit.
- 2** Undo the two screws (M3) using a Phillips screwdriver and remove the complete plastic cover from the burner control unit.

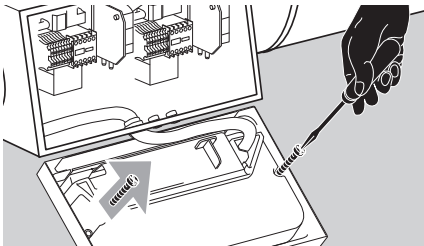

Internal connection diagram

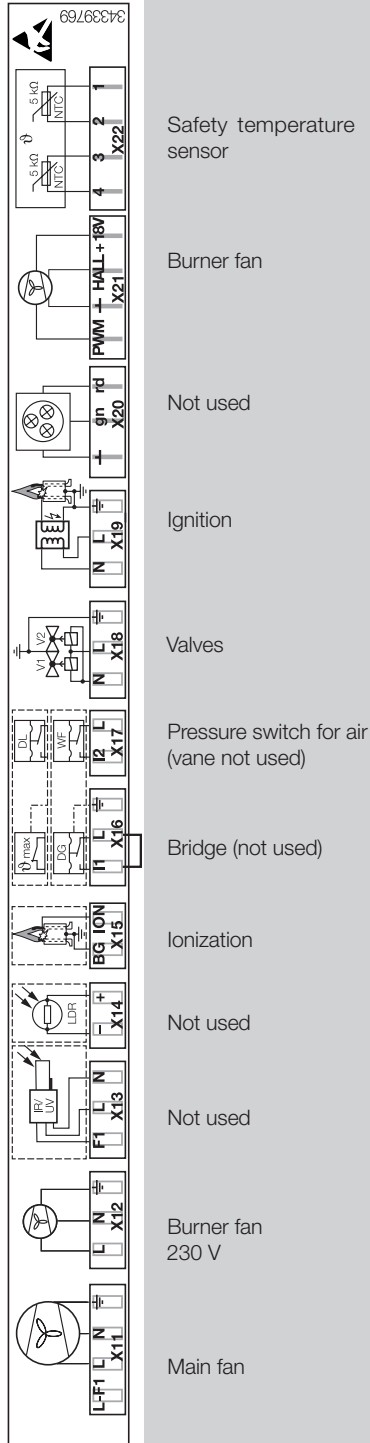

- 3 Press the RESET button to reset. The unit then reverts to the last operating mode selected.

▷ Possible faults:

Display	Fault type
F	Flame fault
R	Air fault
C	Temperature fault
E	Electronics fault
U	Other possible faults

- 4 If the burner control unit does not respond even though all the possible faults have been rectified as described below, contact your supplier.

? Fault

! Cause

• Remedy

? The 7-segment display has gone out despite the voltage supply being OK?

- ! Fuse F2 is defective.

- Check the fuse contacts.

There is a spare fuse directly next to the fuse holder.

Attention! Fit the correct fuse for 4 A.

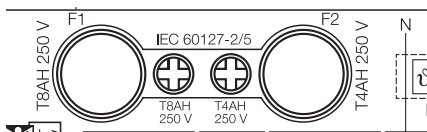

? Error code F. and ! flash alternately?

On burner start-up, the burner control unit has not detected a flame during the safety time. Several automatic start-up attempts will be completed if a restart has been programmed.

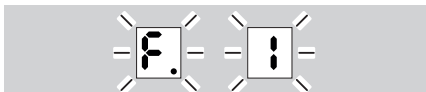

- ! Inadequate inlet pressure available.
- Check the inlet pressure.
- ! Ignition is not working properly.
- Check the connection of the ignition cables for damage or moisture. The spark plug must be fitted correctly.
- Check the ignition spark acoustically during the 3-second ignition time from the burner fan side.
- Clean the spark electrode.
- Check the ignition transformer and replace it if necessary.
- ! Poor flame signal due to incorrect burner adjustment.
- Readjust the CO₂ value, see page 10 (Adjusting the heater).

- ! Poor flame signal due to dirty or badly connected flame rod.

- Check the flame rod and clean it with fine abrasive paper if necessary.
- Check the cable connection, cable and terminal boot for damage or moisture. The terminal boot must be fitted correctly.
- Check the yellow and green burner ground cable for corrosion and to ensure it is firmly connected.
- The flame rod is defective and must be replaced.
- ! Air in the gas pipe.
- Vent the gas pipe.
- ! Valves do not open.
- Disconnect the valve plug on the gas combination control and measure the voltage at the valve plug during the safety time.
- If the voltage is not adequate, first check fuse F2 (4 A). If the display and the LEDs are not lit, it is defective.
- If the voltage is not adequate, replace the gas combination control and return it to the supplier.

? Error code F. and ! flash alternately and the light is red?

The fault could not be rectified. All start-up attempts have been used and the burner control unit goes into lock-out.

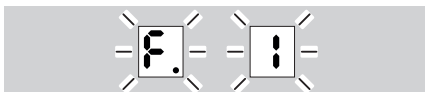

- ▷ Reset is only possible by pressing the RESET button on the burner control unit or using the remote reset if there is one.

- Rectify the cause of the fault as described above for warning F.!

? Error code F. and 2 flash alternately?

The flame has gone out during operation. If a restart has been programmed, an automatic restart will be completed.

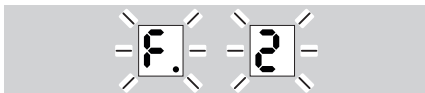

- ! Poor flame signal due to incorrect burner adjustment.
- Readjust the CO₂ value, see page 10 (Adjusting the heater).
- ! Poor flame signal due to dirty or badly connected flame rod.
- Check the flame rod and clean it with fine abrasive paper if necessary.
- Check the cable connection, cable and terminal boot for damage or moisture. The terminal boot must be fitted correctly.
- Check the yellow and green burner ground cable for corrosion and to ensure it is firmly connected.
- The flame rod is defective and must be replaced.

? Error code F and 2 flash alternately and the light is red?

The fault could not be rectified. All start-up attempts have been used and the burner control unit goes into lock-out.

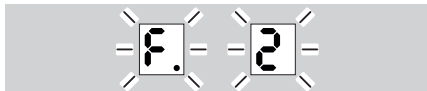

- ▷ Reset is only possible by pressing the RESET button on the burner control unit or using the remote reset if there is one.
- Rectify the cause of the fault as described above for warning F2.

? Error code F and 3 flash alternately?

The burner control unit detects a flame signal during start-up or in fault status.

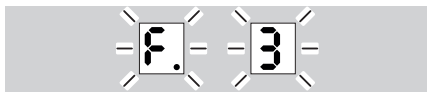

- ! Incorrect flame signal due to leakage/creepage current.
 - Check the wiring, see page 4 (Wiring).
 - Check the flame rod.
- ! Incorrect flame signal through conductive ceramic insulation, e.g. surge via PE wire, possible.
 - Remedy incorrect flame signal. Replace the flame rod and, if necessary, also the complete burner control unit and housing.
- ▷ Reset is only possible by pressing the RESET button on the burner control unit or using the remote reset if there is one.

? Error code R and 4 flash alternately and the light is red?

Burner fan continues to operate when the burner control unit is in idle state.

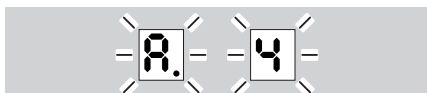

- ! Wiring fault.
 - Check whether the wiring from connector X21 to the burner fan has continuity.
- ! A vacuum is generated in the chimney due to strong wind and this affects the burner fan.

? Error code R and 5 flash alternately?

The burner fan does not reach the required speed when starting up.

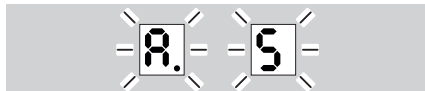

- ! The air supply is blocked.
 - Check the air supply.
- ! The air supply is not OK.
 - Check the air supply and clean it if necessary, see page 12 (Cleaning).
- ! Fan motor defective.
 - Check the motor.
- ! Wiring fault.
 - Check the wiring (connectors X21 and X12).

? Error code R and 5 flash alternately and the light is red?

The fault could not be rectified. All start-up attempts have been used and the burner control unit goes into lock-out.

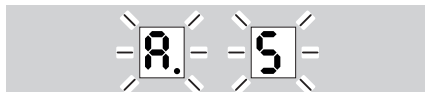

- ▷ Reset is only possible by pressing the RESET button on the burner control unit or using the remote reset if there is one.
 - Rectify the cause of the fault as described above for warning R5.
 - Check the air supply and clean it if necessary.

? Error code R and 6 flash alternately?

The burner fan does not reach the required speed during operation.

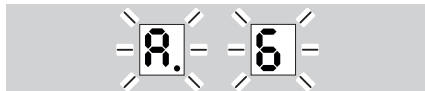

- ! The air supply is blocked.
 - Check the air supply route.
- ! The air supply is not OK.
 - Check the air supply and clean it if necessary, see page 12 (Cleaning).
- ! Fan motor defective.
 - Check the motor.
- ! Wiring fault.
 - Check the wiring (connectors X21 and X12).

? Error code *R* and *B* flash alternately?

The main fan does not start during the start-up attempts.

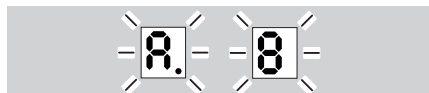

- ! The pressure switch does not switch.
- Check the air hose on the pressure switch for dirt and moisture and clean it.
- Check the pressure switch and replace it if necessary.
- ! The main fan is not working.
- Check the relay and replace it if necessary.
- ! Main fan defective.
- If possible, remove the main fan and replace it.

? Error code *R* and *B* flash alternately and the light is red?

The fault could not be rectified. All start-up attempts have been used and the burner control unit goes into lock-out.

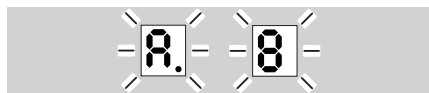

- ▷ Reset is only possible by pressing the RESET button on the burner control unit or using the remote reset if there is one.
- Rectify the cause of the fault as described above for warning *R.B*.

? Error code *R* and *9* flash alternately and the light is red?

The main fan continues to operate after the device has been switched off.

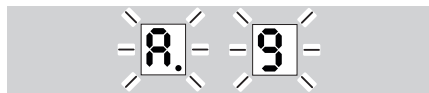

- ! Wiring fault.
- Check the wiring to actuate the main fan, see page 4 (Wiring).
- ! The pressure switch does not switch.
- Check the air hose on the pressure switch for dirt and moisture and clean it.
- ! The main fan is switched off but the pressure switch signal does not drop.
- Check the pressure switch and replace it if necessary.
- ! The relay to actuate the main fan is defective.
- Replace the relay.

? Error code *C* and *I* flash alternately and the light is red after 5 minutes where applicable?

Monitor temperature threshold (STM) of the safety temperature sensor has been exceeded.

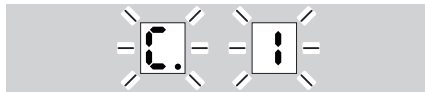

- ! Temperature has been exceeded.
- Leave heater to cool down for longer.
- ! The main fan does not switch on.
- Check the main fan.
- ! Wiring fault.
- Check the wiring to actuate the main fan, see page 4 (Wiring).
- ! Safety temperature sensor is incorrectly aligned.
- Check the position of the safety temperature sensor.
- ! Ambient temperature exceeded.
- The temperature is > 40°C. Allow the room to cool.
- ! The safety temperature sensor is measuring an incorrect temperature.
- Replace the safety temperature sensor.
- ! The heater is badly soiled.
- The heater must be cleaned urgently.
- ! Installation position.
- The heater is too close to other heaters, see page 2 (Installation).
- ! Incorrect λ or O_2 value.
- The heater is not set correctly and must be adjusted, see page 10 (Adjusting the heater).
- ! In the event of a power failure during operation, the heater will be switched off without a cooling phase. In the event of a brief power failure (< 5 minutes), the heat exchanger will heat the device excessively.
- Once the voltage supply has been restored, Controlled air flow mode is activated. The heater is cooled for a maximum of 1 minute.

? Error code *C* and *2* flash alternately and the light is red?

Limit temperature threshold (STL) of the safety temperature sensor has been exceeded.

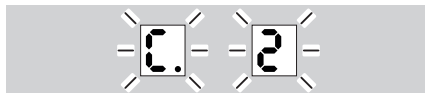

- ! The cause of the fault as described above for warning *C.I* could not be rectified.
- Check the heater for damage, see page 20 (Visual inspection).

? Error code E and 3 flash alternately and the light is red?

Bridge on X16 between I1 and L disconnected.

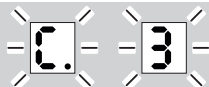

- ! Wiring fault or cable discontinuity.
- Connect cable bridge on X16 between I1 and L.

? Error code E and 4 flash alternately?

Capacity reduction function active. The capacity reduction function is activated 10°C below the monitor temperature threshold (STM) of the safety temperature sensor.

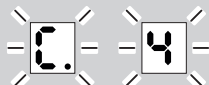

- ! The main fan does not switch on.
- Check the main fan.
- ! Wiring fault.
- Check the wiring to actuate the main fan, see page 4 (Wiring).
- ! Ambient temperature exceeded. The temperature is > 40°C.
- Allow the room to cool.
- ! The heater is badly soiled.
- The heater must be cleaned urgently.
- ! Installation position.
- The heater is too close to other heaters, see page 2 (Installation).
- ! Incorrect burner adjustment. The heater is not correctly set.
- Adjust the heater, see page 10 (Adjusting the heater).

? Error code E and 9 flash alternately and the light is red?

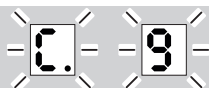

- ! Safety temperature sensor incorrectly connected.
- Check contact at connector X22.
- ! Safety temperature sensor is below -30°C.
- ! Safety temperature sensor is defective.
- Replace the safety temperature sensor.

? Error code E and 1 flash alternately?

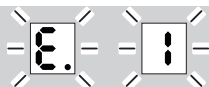

- ! The remote reset input is defective.
- If you use the remote reset input, contact your supplier.

? Error code E and 2 flash alternately and the light is red?

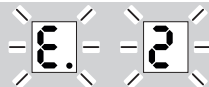

- ! An adjustable parameter and the CRC check are not the same. The parameters are implausible.
- Order a new BCC. Contact your supplier.
- ▷ Reset is only possible by pressing the RESET button on the burner control unit or using the remote reset if there is one.

? Error code E and 3 flash alternately and the light is red?

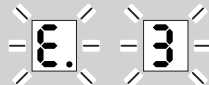

- ! A fixed parameter and the CRC check are not the same. The parameters are implausible.
- Order a new BCC. Contact your supplier.
- ▷ Reset is only possible by pressing the RESET button on the burner control unit or using the remote reset if there is one.

? Error code E and 4 flash alternately and the light is red?

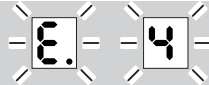

- ! Limits for fixed parameters not observed.
- Order a new BCC. Contact your supplier.

? Error code E and 5 flash alternately and the light is red?

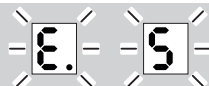

- ! The BCC is not connected.
- Connect the BCC to the printed circuit board.

? Error code E and 6 flash alternately and the light is red?

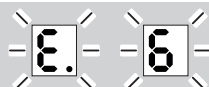

- ! An incorrect BCC is connected. The BCC must be compatible with the ACU of the RGA 100.
- Remove the BCC and connect the correct BCC to the printed circuit board, see page 7 (Burner Chip Card (BCC)).

? Error code E and 8 flash alternately?

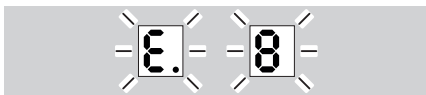

- ! Programming mode is active.
- As soon as Programming mode has been deactivated, the display will go out.

? Error code E and 9 flash alternately?

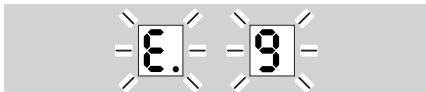

- ! Internal electronics fault.
- Remove the BCC and send it to your supplier.
- ! Fuse defective.
- Check external fuse F1 (8 A).

? Error code U and 1 flash alternately and the light is red?

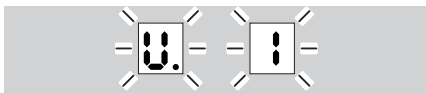

- ! Voltage supply is below the limit (programmable limit, e.g. < 160 V).
- Ensure that adequate mains voltage is supplied.

? Error code U and 2 flash alternately and the light is red?

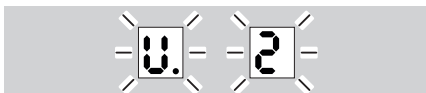

- ! Voltage supply is above the limit (programmable limit, e.g. > 260 V).
- Ensure that adequate mains voltage is supplied.

? Error code U and 3 flash alternately and the light is red?

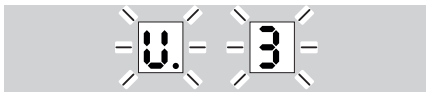

- ! All start-up attempts in the programmed voltage range (e.g. 160 – 180 V) were unsuccessful. The last start-up attempt is not made to prevent a lock-out.
- Ensure that adequate mains voltage is supplied.

? Error code U and 5 flash alternately and the light is red?

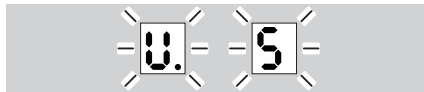

- ! While a fault was pending, the unit has been successfully reset more than 5 times within 15 minutes using the remote reset input.
- ▷ Reset is only possible by pressing the RESET button on the burner control unit or using the remote reset if there is one.

? Error code U and 6 flash alternately and the light is red?

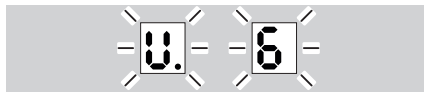

- ! The unit has been unsuccessfully reset more than 10 times within 15 minutes using the remote reset input.
- ▷ Reset is only possible by pressing the RESET button on the burner control unit or using the remote reset if there is one.

? A circulating dash is displayed rather than an error code?

- ▷ After switching on the voltage, a circulating dash is displayed.



- ▷ Three possible pieces of information are output:
 - ! Switch-on delay time running.
Or
 - ! Cycle lock active. The time (cycle lock) between two starts is too short.
 - The display will go out automatically as soon as the time between two starts is long enough. The burner control unit will ensure a pause between start-up attempts on the basis of its parameterization. This warning is displayed during this time.
Or
 - ! The main fan is switched off but the pressure switch signal does not drop. A burner restart is not possible.
 - After 25 s, the display will change to error code R 9.

Maintenance

! CAUTION

To ensure that no damage occurs during operation and maintenance, please observe the following instructions. Otherwise, injuries or damage to the device may occur and/or the function of the device may be impaired. The supplier/manufacturer cannot accept liability for damage resulting thereof.

- Have the heater cleaned at least once a year by qualified maintenance personnel.
- Have the safety functions checked at least once a year by qualified maintenance personnel, see page 21 (Checking the safety functions and burner operation).
- Check the chimney once a year with your local chimney sweep to find whether the flue gas and air supply routes are clear.
- Sharp-edged metal sheets. Always wear protective gloves.
- After cleaning or repair work, check that the components on and in the heater are in good condition. The device may only be restarted if all safety devices have been installed and the safety functions have been checked, see page 21 (Checking the safety functions and burner operation).

- 1** Switch off the burner control unit.

Visual inspection

- 2** Check all heaters for dirt and clean them accordingly, see page 12 (Cleaning).
- 3** Check all heaters for damage and loose parts.
- 4** The rubber seals between the electrodes and terminal boots may be displaced by the water jet. Check whether the seals are fitted correctly.
- 5** Check the internal air hose **5** for damage.

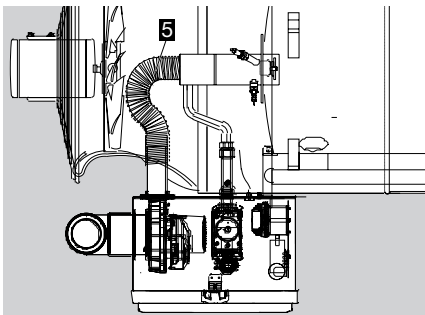

- 6** Check the wiring.
- 7** Check the cable glands.
- 8** Depending on the number of operating cycles, we recommend that the spark electrode and flame rod be replaced once per year.
- 9** Check the seal on the housing cover of the burner control unit. Replace it if necessary.

- 10** Check the inside of the housing cover for traces of dust, dirt or moisture. If you find such traces, the cause must be rectified at all times, e.g. by sealing an open cable gland.
- 11** Check the cable harness and wiring for signs of damage.

Number of operating cycles

- 2** Check the number of operating cycles (heater ON): the number of operating cycles can be displayed by pressing and holding the RESET button. The number of operating cycles is composed as follows in alternating displays:
The first character (X) stands for X,000,000 operating cycles, the second character (Y) stands for Y00,000 operating cycles. For example, the first character is the number 2.: the unit has exceeded 2,000,000 operating cycles. The second character is the number 3: the unit has exceeded 300,000 operating cycles. The total number of operating cycles is composed of the numbers 2 and 3. This gives a total number of operating cycles of 2,300,000.
- 3** Disconnect the system from the electrical power supply.
 - ▷ The heater may only be disconnected from the electrical power supply once the device has been switched off and post-cooling is complete.
- 4** Shut off the gas supply.

Checking the safety functions and burner operation

⚠ WARNING

Risk of explosion!

- If these checks are not carried out, the gas valves might remain open allowing non-combusted gas to escape.

Safety functions

- 1** Switch off the heater during operation. Press ON/OFF .
 - ▷ The flame goes out < 1 s.
 - ▷ The main fan cools the heater down until it reaches switch-off temperature.
- 2** Remove the valve plug on the combination control during operation.
 - ▷ The gas valves close < 1 s.
 - ▷ The flame goes out.
 - ▷ The burner control unit displays the warning message "The flame has gone out during operation". Error code *F* and *2* flash alternately.
 - ▷ If a restart has been programmed, the burner control unit will initially attempt to restart and will then perform a fault lock-out. Error code *F* and *f* flash and indicate the fault message "No flame has been detected during the safety time".
- 3** Shut off the inlet pressure during operation.
 - ▷ The burner control unit performs a safety shut-down: the gas valves are disconnected from the electrical power supply.
 - ▷ The flame goes out.
 - ▷ The burner control unit displays the warning message "The flame has gone out during operation". Error code *F* and *2* flash alternately.
 - ▷ If the burner control unit responds in a different way to that described, a fault has occurred, see page 14 (Assistance in the event of malfunction).

! CAUTION

The fault must be remedied before the system may be operated.

Checking burner operation

- 1** Switch on the burner control unit ACU.
 - 2** Select operating mode  Heating.
 - 3** Check the burner settings, see page 10 (Adjusting the heater).
- ▷ Settings data, see service form in housing cover. Update if necessary.

Accessories

Room thermostat

Use a room thermostat with a hysteresis of $\pm 1^{\circ}\text{C}$, 230 V, Type TH 215.

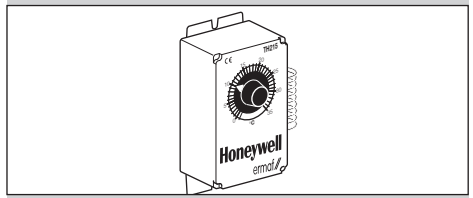

Order No.: N50260145

Pressure reducer

Pressure reducer for LPG.

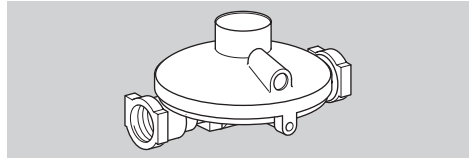

RECA 1.5 bar to 50 mbar, 2 x 1/2" internal thread connection, 10 kg/h, Order No.: N52600023.

Manual valve

Manual valve for gas.

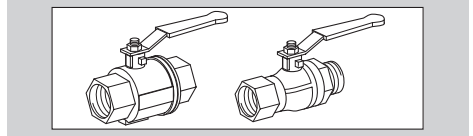

2 x 1/2" internal thread connection,

Order No.: N52600019.

1/2" internal and external thread connection,

Order No.: N52600027.

BCSoft

There are two PC opto-adapters (PCO) available for the connection to the PC and BCSof:

Wireless connection using Bluetooth technology:

Bluetooth adapter PCO 300

Including BCSof CD-ROM,

Order No.: N70000066.

Cable connection via USB interface:

Opto-adapter PCO 200

Including BCSof CD-ROM,

Order No.: N70000065.

- ▷ See PCO 200 and PCO 300 operating instructions at www.docuthek.com.
- ▷ The current BCSof software can be downloaded from our Internet site at www.docuthek.com. To do so, you need to register in the DOCUTHEK.

Connection kit

Connection kit for natural gas

Manual valve and gas hose to connect the gas combination control CG to the gas supply.

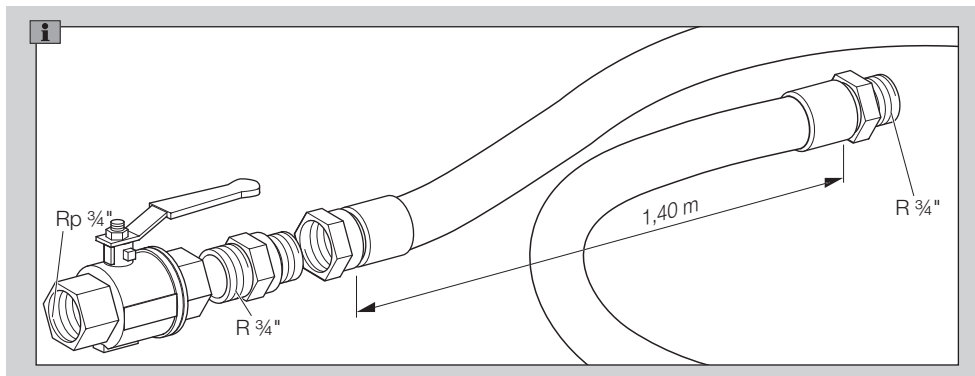

Connection kit: R 3/4" threaded connection, total length = 1.50 m, Order No.: N70000013.

Connection kit for propane

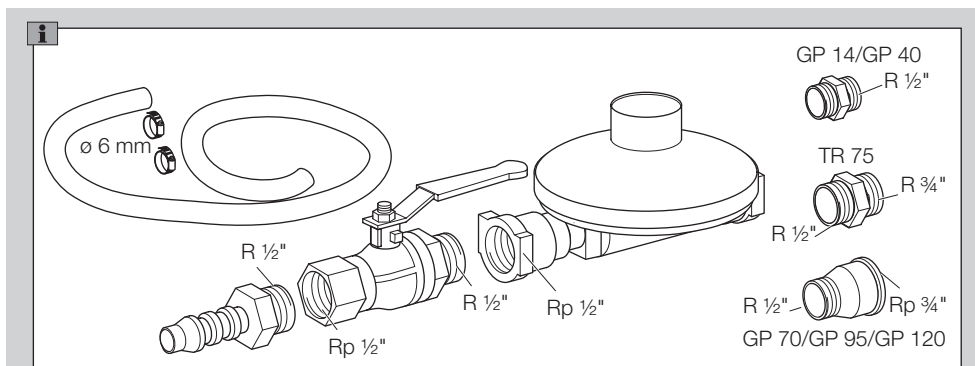

Pressure reducer, manual valve, hose (length = 2 m), 2 hose clamps, R 1/2" double nipple for GP 14/GP 40, R 1/2"/R 3/4" double nipple for TR 75, R 1/2" – Rp 3/4" reducing fitting for GP 70 – GP 120, to connect the gas combination control CG to the gas supply, Order No.: N70000014.

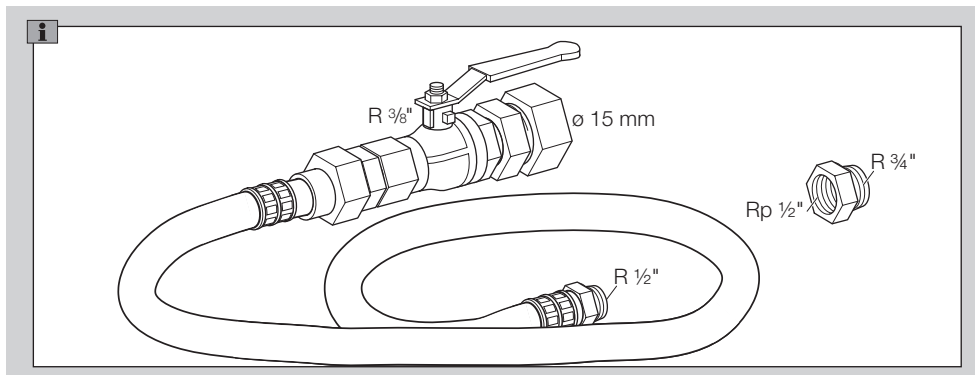

Manual valve and hose (DVGW certified, length = 2 m) to connect the gas combination control CG to the gas supply, Order No.: N52990209. Rp 1/2" – R 3/4" connector, Order No.: N70000018.

Chimney

Double-walled coaxial chimney with integrated flue gas and air supply route, category C33.

- ▷ Internal/External diameter: 150/250 mm, length: 2–5 m.

! CAUTION

To avoid damage during operation, please observe the following instructions:

- The RGA 100 is only deemed CE tested and approved when used with the coaxial chimney described below.
 - Do not exceed the maximum length of the chimney. Otherwise the CE approval will be voided and the function of the device may be impaired. The supplier/manufacturer cannot accept liability for damage resulting thereof.
 - Check the applicable building regulations, standards and the relevant accident prevention regulations before installation. The same applies to the erection and maintenance of a scaffold.
- ▷ The design of the chimney depends on the premises and the roof construction.
 - ▷ Before installation, the site and any wall mounting which may be required for a chimney length in excess of 2 m must be defined.
 - ▷ The elements are sealed and connected using clamp strips. Each chimney element is supplied with a clamp strip. A seal is provided for each clamp strip which is either integrated or supplied loose.
 - ▷ The clamp strips are only designed for sealing and connection purposes, not for absorbing axial forces.
 - ▷ Any roof transit plate depends on the roof construction and must be ordered separately.
 - ▷ Standard chimney kit, Order No. N50820003

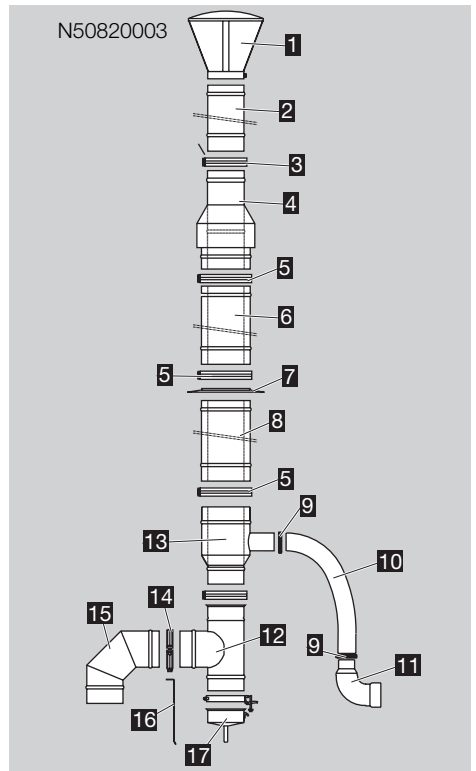

	Designation	Order No.	Length [mm]
1	Rain cap	N50820112	
2	Pipe, Ø 150	N50820111	500
3	Clamp, Ø 150	N50820109	
4	Adapter, Ø 150 – Ø 200	N50820077	
5	Clamp, Ø 200	N50820110	
6	Double-walled pipe, Ø 200	N50820097	500
7	Roof transit plate, Ø 320	N50820085	
8	Double-walled pipe, Ø 200	N50820069	1000
9	Hose clamp, Ø 77 – Ø 95	N50820057	
10	Hose, Ø 75	N70000073	2000
11	Coupling with 90° PVC elbow (on the operating box)		
12	Tee, Ø 150	N50820098	
13	Adapter with fresh air connection, Ø 150	N50820107	
14	Clamp, Ø 150	N50820055	
15	90° elbow, Ø 150	N50820108	
16	Chimney bracket	N50820008	
17	Condensation pipe with clamp	N50820099	

Application examples

This example of application shows the chimney as a standard kit.

- ▷ Standard chimney kit, length 3,450 mm, Order No. N50820003

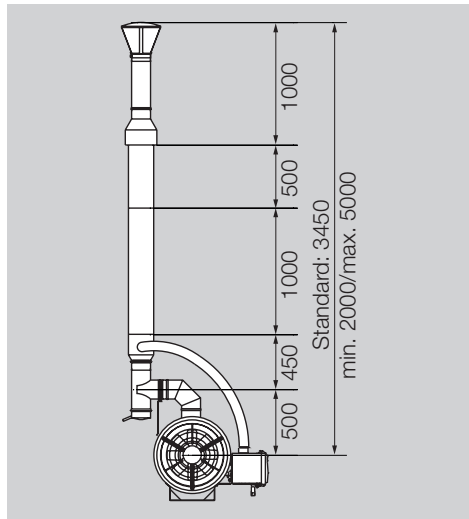

This example of application shows the chimney with the maximum installation length of 5 m.

- ▷ The chimney is routed sideways along the exterior wall rather than on the roof. Additional elbows from the accessories range are used for this purpose.

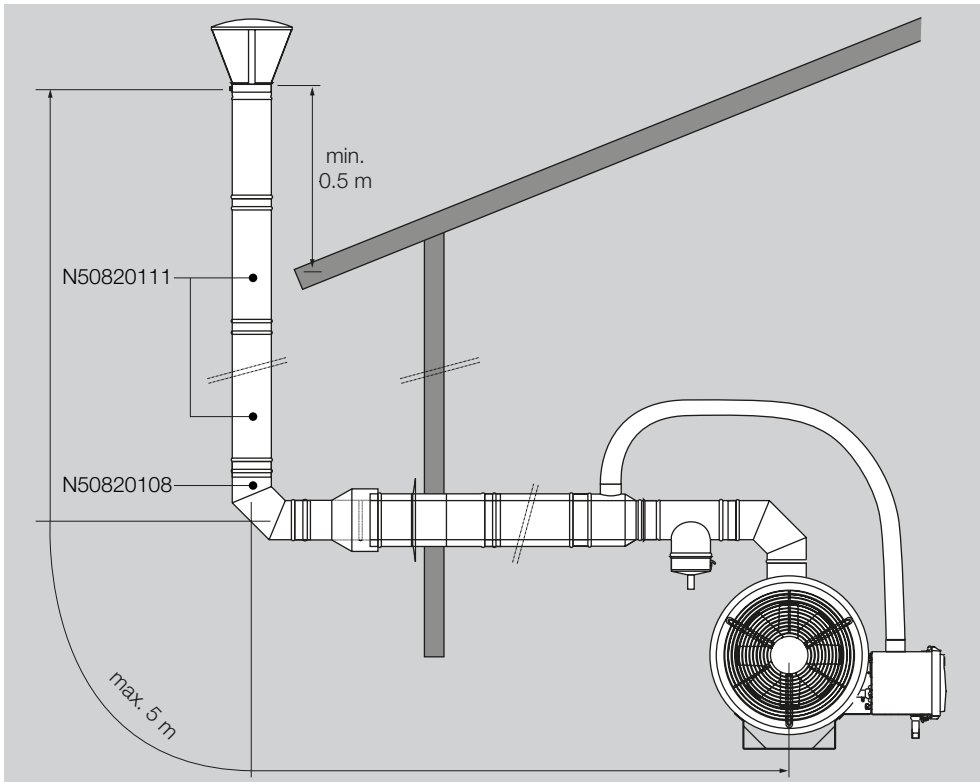

- ▷ Standard chimney kit, 2 x pipes, Order No.: N50820003 + 2 x N50820111 + 3 x N50820109 + N50820108
- ▷ Additional wall brackets may be required (not included in the delivery).

Spare parts

- ▷ When ordering spare parts, please quote the order number along with the designation and item no. of the spare part as well as the heater serial number.
- ▷ When ordering spare parts which are not listed here below, please quote the edition of these operating instructions and the heater serial number.
- ▷ Use genuine spare parts only to ensure the replacement complies with the requirements stipulated by the manufacturer.

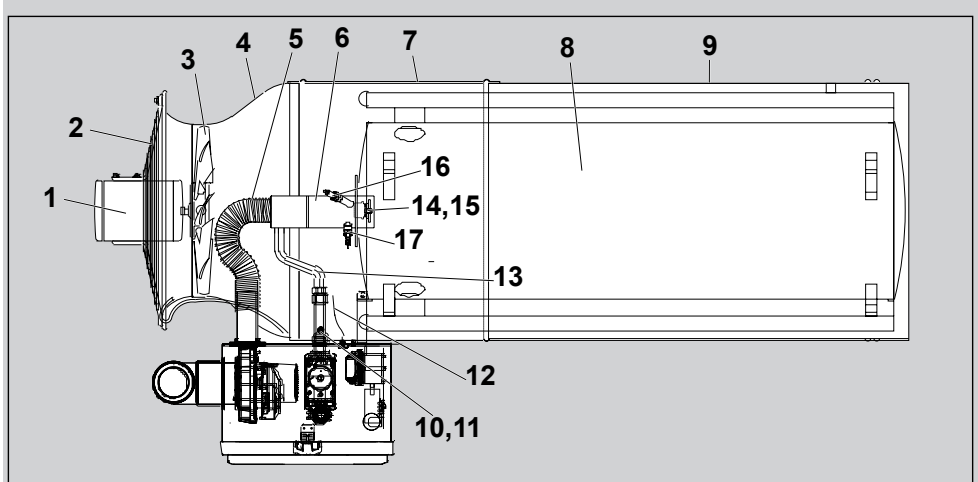

Item	Order number	Designation
1	N50820001	Motor Elnor BX275
2	N50820031	Safety grille for RGA 100
3	N50820029	Fan, 400 mm, white, 8 blades
4	N70400004	Air inlet duct for RGA 100 ACU
5	N50820048	Air hose, internal
	N50820049	Compression fitting (2 x)
6	N50820018	Burner RGA 100 V4 without accessories
7	N70400002	Housing, short, ACU
8	N50820070	Burner chamber for RGA 100, complete
9	N50820013	Housing, long
10	N70400010	Gas outlet
11	N50390117	Pressure test point, 1/8"
12	N70400003	Temperature sensor for RGA 100 ACU
13	N50820059	Gas hose, stainless steel, flexible
14	N50820021	Injection nozzle: natural gas (12 x Ø 3.0 mm)
	N50400066	Injection nozzle: propane (12 x Ø 1.8 mm)
15	N50260167	Burner baffle plate (Ø 48 mm)
16	N50820082	Flame rod
17	N50260030	Spark electrode

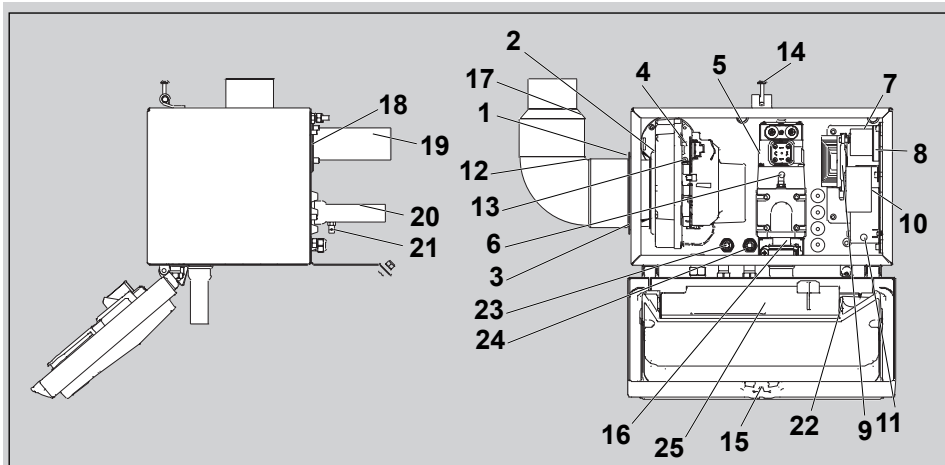

Item	Order number	Designation
1	N70400001	Air inlet seal, D 98 (RGA 100 flue gas seal)
2	N70400014	Air inlet pipe
3	N70400015	Fan air inlet seal, D 70
4	N70000082	Burner fan
5	N50280116	Combination control CG 2
6	N50820041	Pipe coupling, straight, brass
7	N50260024	Motor relay
8	N51600011	Relay socket for RGA 100 ACU
9	N70000037	Air pressure switch
10	N52800034	Capacitor for RGA 100
11	N50260109	Ignition transformer
12	N70400006	Pipe elbow, air
13	N70000031	Air outlet seal (square hole)
14	N70400016	Upper hinge pin (pivot + screw) for RGA 100
15	N70300005	ACU 121, complete
16	N50280136	Gas inlet pipe
17	N70400007	70–100 air inlet reduction
18	N70400008	Air outlet seal, D 49
19	N70400009	Air outlet pipe
20	N70400010	Gas outlet pipe
21	N50390117	Pressure test point
22	N70400002	Burner Chip Card (BCO) for RGA 100 ACU
23	N70400011	Ionization cable kit
24	N70400012	Ignition cable kit
25	N70400013	Cable harness for RGA 100 ACU

Technical data

Gas types: II2ELL3B/P,
 natural gas H and L (gases of category 2);
 LPG, gaseous (gases of category 3): propane,
 propane/butane, butane.
 Fused with 10 A.
 NOx Class: depending on gas type up to Class 5.
 Inlet pressure p_i : 20 to 70 mbar.
 Resistant to high-pressure cleaning.
 Gas connection: Rp 3/4 to ISO 7-1.
 Staged control: On/Off signal (240 V AC or
 24 V AC/DC via coupling relay).

Continuous control: capacity control from
 60 – 100% (0 – 10 V/0 – 20 mA actuating signal).
 Max. efficiency: 75 kW = 93%, 45 kW = 98%.
 Burner control unit with direct spark ignition and
 ionization control.

Fan type:
 main fan: axial, burner fan: radial.

Material:
 housing: stainless steel,
 heat exchanger: stainless steel,
 burner control unit: flame-retardant polymer blend
 made of polycarbonate (PC) and acrylonitrile
 butadiene styrene copolymer (ABS).

Ambient temperature $T_{\max.} \leq 40^{\circ}\text{C}$,
temperature differential $\Delta T_{\max.} \leq 35^{\circ}\text{C}$,
example for calculating the jet temperature:

$T + \Delta T = 40^{\circ}\text{C} + 35^{\circ}\text{C} = 75^{\circ}\text{C}$.

No condensation permitted.

Storage temperature: -20 to $+50^{\circ}\text{C}$.

Cycle lock: 15 s.

Capacity: 60–100 kW.

Jet length: > 40 m,

velocity at the jet end: 0.5 m/s.

Gas consumption:

natural gas L: 11.0 m³/h,

natural gas H: 9.6 m³/h,

propane: 6.3 kg/h,

butane: 7.2 kg/h.

Connection rating:

230 V AC, $-15/+10\%$, 50 Hz, 1250 W.

Current consumption I_N : 5.4 A.

Air circulation:

controlled air flow: ± 5000 m³/h,

heating: ± 7000 m³/h.

Dimensions: 1940 x 910 x 653 mm.

Sound level: ≤ 68 dB.

Weight: 130 kg.

The Netherlands

The device has been designed for equipment category K (I2K) and is suitable for use with distribution gases G- and G+ in accordance with the specifications set out in NTA 8837:2012, Annex D, with a superior Wobbe index of 43.46 – 45.3 MJ/m³ (dry, 0°C) or 41.23 – 42.98 (dry, 15°C).

In addition, this device can be converted to equipment category E (I2E) and/or calibrated.

This means the device “is suitable for G+ gas and H gas or proven to be suitable for G+ gas and proof has been provided that it can be converted for use with H gas” as defined by the “Dutch Decree of 10 May 2016 regarding amendment of the Dutch Gas Appliances Decree ...”.

Certification

Declaration of conformity



We, the manufacturer, hereby declare that the product RGA 100 complies with the requirements of the listed Directives and Standards.

Directives:

- 2014/30/EU
- 2014/35/EU

Regulation:

- (EU) 2016/426 – GAR

Standards:

- EN 525:2009
- EN 1020:2010
- EN 60335-1:2012
- EN 60335-2-102:2016
- EN 55011:2016
- EN 61000-6-2:2016
- EN 50465:2015

The relevant product corresponds to the tested type sample.

The production is subject to the surveillance procedure pursuant to Regulation (EU) 2016/426.

Elster-Instromet B.V.

Scan of the Declaration of conformity (D, GB) – see www.docuthek.com

Eurasian Customs Union



The product RGA 100 meets the technical specifications of the Eurasian Customs Union.

Logistics

Transport

Protect the unit from external forces (blows, shocks, vibration). On receipt of the product, check that the delivery is complete, see page 2 (Part designations). Report any transport damage immediately.

Storage

Store the product in a dry and clean place.

Storage temperature: see page 26 (Technical data).

Storage time: 6 months before using for the first time. If stored for longer than this, the overall service life will be reduced by the corresponding amount of extra storage time.

Packaging

The packaging material is to be disposed of in accordance with local regulations.

Disposal

Components are to be disposed of separately in accordance with local regulations.

Goods return form

Name of the operator

P.O. Box/Street

Postcode and town/city

Tel.

E-mail

 Returned by (Mr./Ms.)

Date

Number of returns

Heater serial number

Power supply [V/Hz]

Inlet pressure p_u [bar]

Reasons for return

Description of fault

Desired action

Credit note

Replacement

Repair

Remarks

Date and signature

Please send returns back to your supplier.

Contact

Honeywell

Elster s.r.o.
Nám. Dr. A. Schweitzera 194
916 01 Stará Turá
Slovakia
Tel. +421 32 775 26240
Fax +421 32 776 2658
orders.ermaf@elster.com, www.ermaf.nl

We reserve the right to make technical modifications
in the interests of progress.